



CATALOGO SEDILI WC  
*Toilet seats Catalogue*





Saniplast nasce nel 1962 e si specializza fin da subito nella produzione di sedili wc in termoindurente. Con tre stabilimenti di produzione in Italia, l'azienda propone al proprio cliente un'offerta vasta e completa per l'arredo bagno, dai sedili wc, agli accessori bagno, fino al tappeto bagno o multiuso realizzato in cotone rigenerato. Esperienza, competenza e flessibilità produttiva sono da sempre i valori cardine della azienda che offre un prodotto a marchio Saniplast di qualità e alte prestazioni.



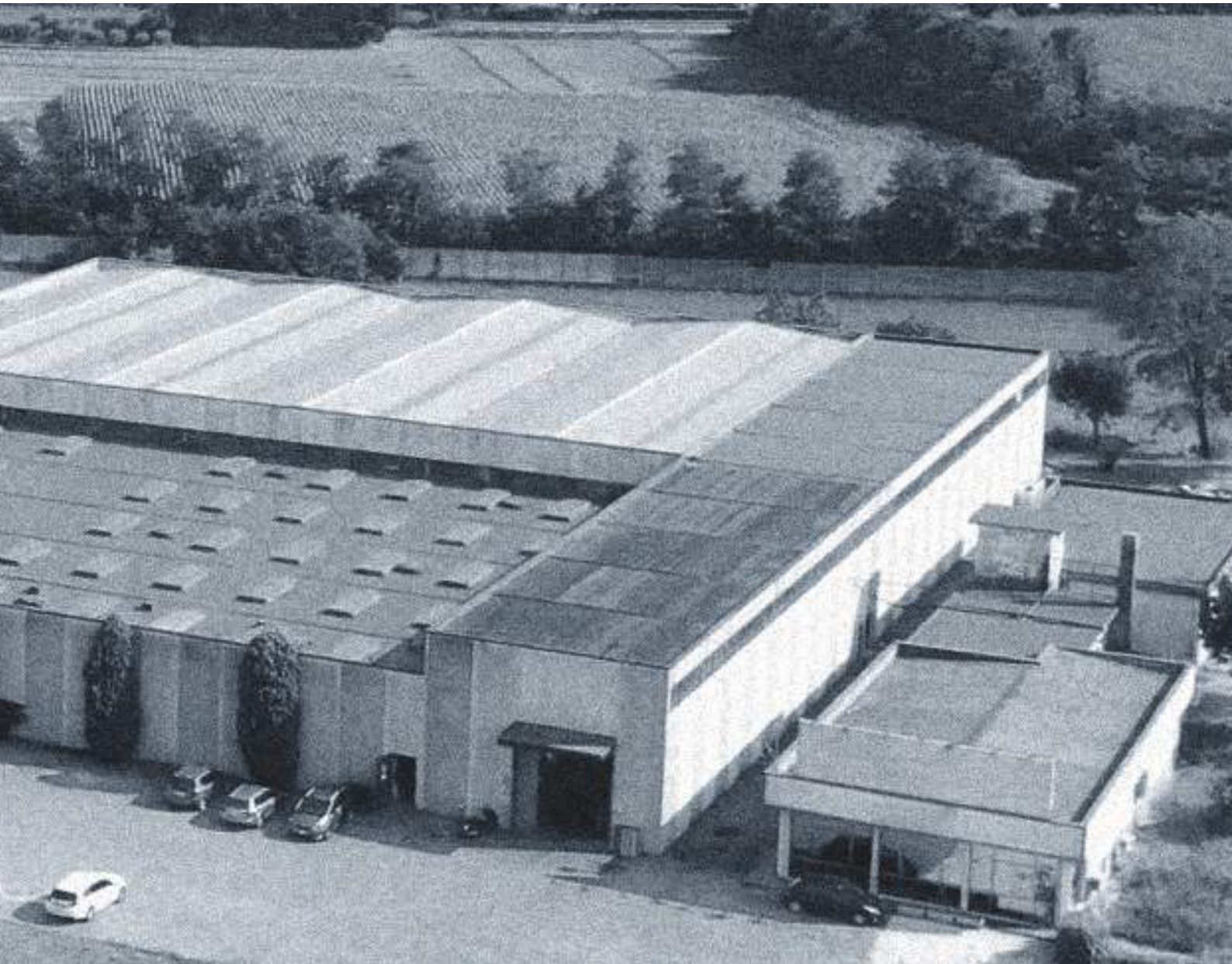

*Saniplast was founded in 1962 and immediately specialized in the production of Duroplast toilet seats. With three production plants in Italy, the company offers its customers a wide and complete range of bathroom furnishings, from toilet seats, bathroom accessories, to bathroom or multipurpose rugs made of regenerated cotton.*

*Experience, competence and production flexibility have always been the key values of the company that offers a Saniplast branded product of quality and high performance.*



 **saniplast®**  
**saniplast**

the Blue experience

# INDICE/ INDEX

CARATTERISTICHE DEI MATERIALI MATERIAL FEATURES	pag. 06
CERNIERE SLOW CLOSE E STANDARD SLOW-CLOSE AND STANDARD HINGES	pag. 08
SEDILI WC IN TERMOINDURENTE A FORMA DEDICATA DEDICATED SHAPED DUROPLAST WC SEATS	pag. 10
SEDILI WC IN TERMOINDURENTE A FORMA UNIVERSALE UNIVERSAL SHAPED DUROPLAST WC SEATS	pag. 52
SEDILI WC IN TERMOINDURENTE A FORMA UNIVERSALE DECORATI DECORATED UNIVERSAL SHAPED DUROPLAST WC SEATS	pag. 77
SEDILI WC IN TERMOPLASTICO A FORMA UNIVERSALE UNIVERSAL SHAPED THERMOPLASTIC WC SEATS	pag. 86
ADATTABILITÀ PRINCIPALI DEI SEDILI WC IN TERMOINDURENTE MAIN ADAPTABILITY OF DUROPLAST WC SEATS	pag. 91
SEDILI WC IN LEGNO FSC WC SEATS IN FSC WOOD	pag. 103
PARTE TECNICA INFORMATIVA DELLE ADATTABILITÀ DEI SEDILI WC ADAPTABILITY AND TECHNICAL INFORMATION FOR WC SEATS	pag. 116
GAMMA SEDILI WC PER DISABILI CON E SENZA COPERCHIO DISABLES WC SEATS WITH AND WITHOUT COVER	pag. 157
ADATTABILITÀ SEDILI WC PER CASA CERAMICA WC SEATS ADAPTABILITY BY CERAMIC MANUFACTURES	pag. 159
RICAMBI PER TUTTA LA GAMMA SEDILI WC SPARE PARTS FOR WC SEATS	pag. 169
ESPOSITORE ECO PER SEDILI WC ECO DISPLAY STAND FOR WC SEATS	pag. 178
CONDIZIONI GENERALI DI VENDITA GENERAL SALES CONDITIONS	pag. 179
INDIVIDUA IL TUO SEDILE WC IDENTIFY YOUR TOILET SEAT	pag. 183

## Sedili wc in termoindurente Duroplast toilet seats

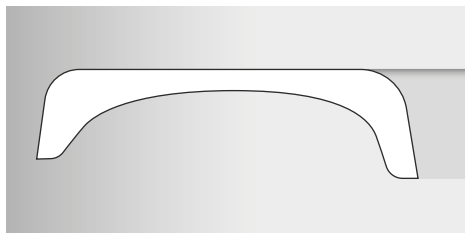

I sedili in termoindurente Saniplast sono realizzati per stampaggio a compressione a caldo di masse ureiche. Il risultato di questa produzione è un articolo con una superficie brillante, robusta, molto simile d'aspetto alle ceramiche wc.

*Saniplast Duroplast seats are made through a hot molding process of urea material. The result of this production process is a product with a bright and resistant surface, looking similar to the ceramic bowls.*



Resistenti alla rottura  
Resistenti ai graffi  
Stessa lucentezza della ceramica  
Antistatici respingono la polvere  
Non sono soggetti al viraggio di colore nel tempo  
Resistenti ai più comuni agenti chimici  
Non è necessario usare detergenti aggressivi  
Sono autoestinguenti  
Ambientalmente compatibili  
Non contengono sostanze pericolose

*Durable products  
Anti scratch products  
As bright as ceramic  
Antistatic, dust repellent  
Long lasting colours in time  
Resistant to the common chemical cleaners  
No need to use hard cleaners  
Self-extinguishing / fire-proof  
Environmental friendly  
They do not contain dangerous substances*



Investimento iniziale consistente

*High initial investment*

## Sedili wc in termoplastico Thermoplastic toilet seats

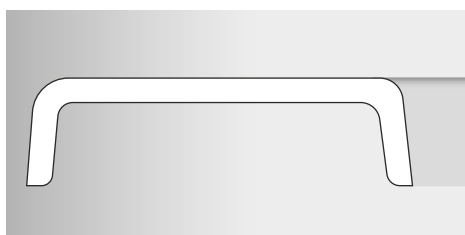

I sedili in termoplastico Saniplast sono realizzati tramite stampaggio ad iniezione. Ci sono differenti tipologie di materiale termoplastico, ma il materiale più utilizzato per i sedili wc è il polipropilene. Il risultato di questo processo produttivo è un articolo con un peso leggero, resistente nel tempo.

*Saniplast thermoplastic seats are made through an injection molding process. The main thermoplastic material used for the production of toilet seats is polypropylene. The result of this production process is a light and resistant product.*



Sono molto leggeri  
Sono di primo prezzo  
Indicati per le forniture a locali pubblici  
Il materiale è riciclabile

*Light weight  
First market price product  
Suitable for public places  
Recyclable material*



La superficie si può graffiare  
Investimento iniziale consistente  
Possono ingiallire nel tempo

*Soft surface easy to scratch  
High initial investment  
Colour may change in time*



## Sedili wc in legno Mdf FSC® FSC® Mdf toilet seats

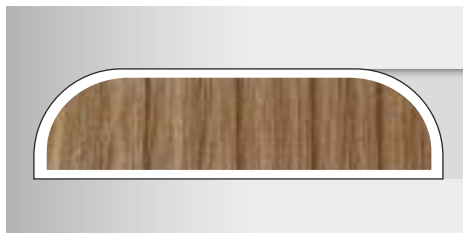

I sedili Saniplast sono realizzati con un'anima in FSC® mdf, legno proveniente da foreste gestite in maniera corretta e responsabile secondo rigorosi standard ambientali, sociali ed economici.

*Saniplast seats are made with a core in FSC® mdf, wood from forests managed correctly and responsibly according to strict environmental, social and economic standards.*

L'anima è ricoperta da diversi strati di verniciatura e il risultato di questo processo produttivo è un articolo compatto, con colori costanti nel tempo.

Questa tipologia di prodotto rappresenta la versione più economica dei sedili Sanilux.

*Saniplast mdf seats are made with a mdf core covered by several layers of painting coat. They are the economical version of the Sanilux line. The result of this production process is a seat with a solid and colour steady in time.*



Alternativa economica al poliestere  
Colore inalterato nel tempo  
Disponibili in varie forme

*Economical option to the polyester  
Long lasting colour in time  
They can have several shapes*



Si possono graffiare  
Sensibili all'umidità  
Materiali delicati verso detergenti

*The surface can get easily scratched  
Sensitive to moisture  
Delicate against common cleaners*

## Sedili wc in legno truciolare colati poliestere Sanilux Polyester coated wood toilet seats

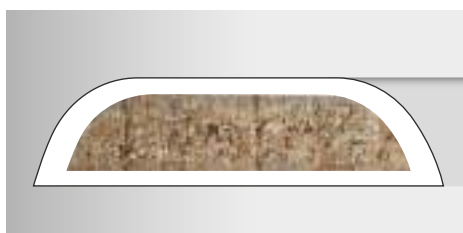

I sedili Sanilux Saniplast vengono realizzati mediante colatura di resina poliestere attorno ad un'anima di legno truciolare. Il risultato di questo processo produttivo è un articolo con una superficie molto compatta e brillante.

*Sanilux Saniplast seats are made by covering a chipboard wood core with a casting of polyester resin. The result of this production process is a seat with a bright and well-refined surface.*



Buona durata nel tempo  
Elevata lucidità della superficie  
Apprezzati perché pesanti  
Possono essere prodotti in svariate forme  
Prodotto di presenza storica nel mercato italiano

*Good durability  
High brightness of the surface  
Heavy seat  
They can have several shapes  
Common material in the Italian market*



Problemi alle cerniere per il peso elevato  
Sono soggetti al viraggio del colore  
Prodotti costosi

*Problems with hinges for the weight of the seat  
Colour may change in time  
Expensive product*

# La cerniera SSCS con sistema brevettato slow close Saniplast Patented SSCS system



Il sedile wc a discesa rallentata è la grande innovazione di questi ultimi anni per il settore dei sanitari ed è diventato un vero e proprio "must".

I sedili wc slow close con sistema SSCS utilizzano una cerniera con tecnologia brevettata Saniplast, interamente "Made in Italy", che assicura performance di alto livello. La possibilità infatti di gestire interamente il ciclo produttivo di questo prodotto, dal sedile alla cerniera, permette di raggiungere e assicurare un prodotto qualitativamente di alte prestazioni e durabilità, a differenza di prodotti simili sul mercato.

*In the last years, slow close toilet seat has represented the great innovation for the bathroom sector and has become a real "must have".*

*The slow close toilet seats with SSCS system use a hinge system with a Saniplast patented technology, entirely "Made in Italy" that ensures high level performances.*

*The possibility to entirely manage the production cycle of this product, from the seat to the hinge, allows to achieve and to ensure a quality product of high performance and durability, unlike similar products.*

## Cerniere a discesa rallentata Slow close hinges



Discesa rallentata  
Slow close



Estraibile  
Quick release



Estraibile con chiave  
Take off



Fissaggio da sotto  
Bottom fixing



Fissaggio da sopra  
Top fixing

### H306



Nylon, regolabile,  
avvitabile dal basso  
Nylon, adjustable and  
bottom fixing

### H323



Metallo regolabile, estraibile,  
avvitabile dall'alto  
Metal adjustable, take off,  
top fixing

### H481



Nylon, regolabile, estraibile,  
avvitabile dall'alto e dal basso,  
coperchietto in metallo  
Nylon, adjustable, quick release,  
top and bottom fixing,  
metal cover

### H482



Nylon, regolabile, estraibile,  
avvitabile dall'alto e dal basso,  
coperchietti in metallo  
Nylon, adjustable, quick release,  
top and bottom fixing,  
metal covers

**H011**



Nylon, regolabile e  
avvitabile dal basso  
*Nylon, adjustable and  
bottom fixing*

**H012**



Nylon, regolabile e  
avvitabile dal basso  
*Nylon, adjustable and  
bottom fixing*

**H013**



Nylon, regolabile e  
avvitabile dal basso  
*Nylon, adjustable and  
bottom fixing*

**H014**



Nylon, regolabile e  
avvitabile dal basso  
*Nylon, adjustable and  
bottom fixing*

**H016**



Nylon, regolabile, estraibile e  
avvitabile dall'alto  
*Nylon, adjustable, take off,  
top fixing*

**H019**



Nylon, regolabile, estraibile e  
avvitabile dall'alto  
*Nylon, adjustable, take off,  
top fixing*

**H025**



S-inox, fissa e avvitabile dal basso  
*S-inox, fixed and bottom fixing*

**H050**



Inox, regolabile, estraibile e  
avvitabile dall'alto e dal basso  
*Inox, adjustable, take off,  
top and bottom fixing*

**H057**



Inox, regolabile e  
avvitabile dal basso  
*Inox, adjustable and  
bottom fixing*

**H341**



Inox, regolabile, estraibile e  
avvitabile dal basso  
*Inox, adjustable, take-off  
and bottom fixing*

**SEDILI WC IN TERMOINDURENTE A FORMA DEDICATA  
DEDICATED SHAPED DUROPLAST WC SEATS**



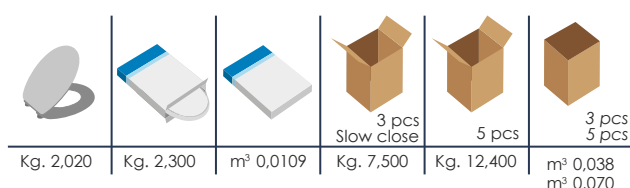
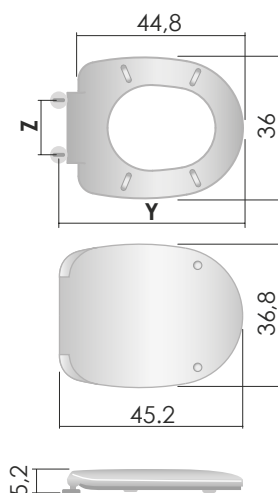

	<b>H011</b>	<b>Cod. 2FSE195702</b>	Y = da 43,2 a 45 Z = da 12,6 a 18,3	Nylon Nylon	
	<b>H025</b>	<b>Cod. 2FSE195802</b>	Y = da 43,2 a 44,3 Z = da 15 a 16	Inox Stainless steel	
	<b>H057</b>	<b>Cod. 2FSE193802</b>	Y = da 42,2 a 46,1 Z = da 13,3 a 17,8	Inox Stainless steel	
	<b>H050</b>	<b>Cod. 2FSE200702</b>	Y = da 41,3 a 46,7 Z = da 9,3 a 19,4	Inox Stainless steel	
	<b>H341</b>	<b>Cod. 2FSE202302</b>	Y = da 40 a 48 Z = da 6 a 22	Inox Stainless steel	
	<b>H306</b>	<b>Cod. 2FSE195902</b>	Y = da 43,2 a 45 Z = da 12,6 a 18,3	Nylon Nylon	
	<b>H323</b>	<b>Cod. 2FSE200002</b>	Y = da 42 a 46,7 Z = da 8,7 a 18,8	Metallo cromato Metal chrome	

**Cod. 2FSE200002 (H323)**

**Cod. 2FSE202302 (H341)**

Althea (Sanitalia)	Cora	Cierre Sanitari	Okay	Gravena	Pendy
Althea (Sanitalia)	Plaza	Cierre Sanitari	Piuma	Hidra	Onda
Althea (Sanitalia)	Rose	Cierre Sanitari	Super	Hidra	Pegaso
Astra	Gemma	Duravit	Nube	Jumbo	Aretha
Astra	Hi-fi	Eos - Simca	Armonia	Jumbo	Arethona
Astra	Mia	Eos - Simca	Astro	Jumbo	Tua
Astra	Serie 83	Eos - Simca	Flower	Keratina	Lito
Axa	Axa2	Eos - Simca	Ola	Keratina	Vergina
Azzurra	Afrodite	Etruria	Alba	Keratan	Elka
Azzurra	Diana	Falerii	Adria	Keratan	Godia
Azzurra	Elena	Falerii	Aida	Roca	Zoom
Azzurra	Elios	Falerii	Giulietta	Sbordoni	Sospesa
Azzurra	Giulia MB	Flaminia	Isabel	Senesi	Sovana
Azzurra	Le Onde	Flaminia	Metro	Simas	Primavera
Azzurra	Midas	Flaminia	Spin	Simas	Selenia
Azzurra	Novecento	G.S.G.	Ambra	Sole	Elisa
Azzurra	Ottocento	Globo	Flavia (Alia)	Vavid	Orientale
Cesame	Aretusa	Globo	Grace	Vincenti	Farah
Cierre Sanitari	Desirée	Globo	Open Space	Vincenti	Uno

Sedile wc in termoindurente  
Duroplast toilet seat



ARIA

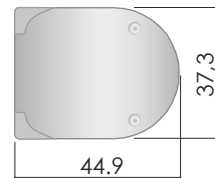
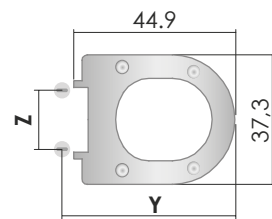

			3 pcs Slow close	5 pcs	3 pcs 5 pcs
Kg. 2,500	Kg. 2,700	m <sup>3</sup> 0,0109	Kg. 8,400	Kg. 14,000	m <sup>3</sup> 0,038 m <sup>3</sup> 0,070

	<b>H057</b>	<b>Cod. 2FSE205102</b>	Y = da 43 a 46,5 Z = da 13,4 a 17,8	Inox Stainless steel	
	<b>H050</b>	<b>Cod. 2FSE203102</b>	Y = da 41,5 a 46,7 Z = da 12,0 a 22,5	Inox Stainless steel	  
	<b>H323</b>	<b>Cod. 2FSE200302</b>	Y = da 41,7 a 46,2 Z = da 11,5 a 21,5	Metallo cromato Metal chrome	  

**Cod. 2FSE205102 (H057)**

Catalano	Canova	G.S.I.	Avant	Olympia	Rubino 2
Cesame	Sintesi Sospesa	G.S.I.	Dafne	Olympia	Serie 92
Cierre Sanitari	Dea	G.S.I.	Desy	Olympia	Serie 92 sospesa
Delta	Gea	G.S.I.	Giulia	Olympia	Vaso c/esalatore
Dolomite	RC 80	Hatria	Dolcevita	Olympia	Vela
Duravit	Dellarco	Hatria-Spea	Marilyn	Olympia	Vela 2
Duravit	Vienna	Ideal Standard	Absolute Kurokawa	Olympia	Vogue
Eos-Simca	Antaga	Incea	Sara	Roca	Tipo
Falerii	Chiara	Kerasan	Montego	Tenax-Simi	Geo
Flamina	App	Laufen	Object	Vavid	Tebe
Flamina	Quick	Olympia	Rubino 1	Volleroy & Boch	Alpina
Flaminia	Link			Volleroy & Boch	Magnum
Globo	Misura 1				

**Cod. 2FSE203102 (H050)**

Flaminia	App	Flaminia	Mini Link	Laufen	Object
Flaminia	Quick	Hatria	Dolcevita		
Flaminia	Link	Ideal Standard	Absolute Kurokawa		

**Cod. 2FSE200302 (H323)**





Catalano	Canova	G.S.I.	Dafne	Olympia	Vela
Cesame	Sintesi Sospesa	G.S.I.	Desy	Olympia	Vela 2
Cierre Sanitari	Dea	G.S.I.	Giulia	Olympia	Vogue
Delta	Gea	Hatria-Spea	Marilyn	Roca	Tipo
Dolomite	RC 80	Incea	Sara	Tenax-Simi	Geo
Duravit	Dellarco	Kerasan	Montego	Vavid	Tebe
Duravit	Vienna	Olympia	Federica	Volleroy & Boch	Alpina
Eos-Simca	Antaga	Olympia	Rubino 1	Volleroy & Boch	Magnum
Falerii	Chiara	Olympia	Rubino 2	Flaminia	Link
Flaminia	Link	Olympia	Serie 92		
Globo	Misura 1	Olympia	Serie 92 sospesa		
G.S.I.	Avant	Olympia	Vaso c/esalatore		

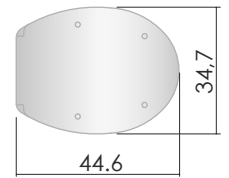
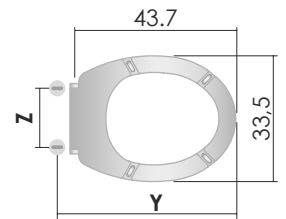

Sedile wc in termoindurente  
Duroplast toilet seat

ARTEX



				
Kg. 1,450	Kg. 1,680	m <sup>3</sup> 0,0120	5 pcs	5 pcs
			Kg. 8,400	m <sup>3</sup> 0,070



H011

Cod. 2FSE036502

Y = da 42,7 a 44,6  
Z = da 11,8 a 18,7

Nylon  
Nylon



H025

Cod. 2FSE036602

Y = da 43 a 44,2  
Z = 15,4

Inox  
Stainless  
steel



Althea(Sanitalia)	Cento	G.S.G.	Alfa	Sbordoni	Flaminia
Althea(Sanitalia)	Hola	G.S.G.	Atene	Scala	Friuli
Archiade	Fausta	G.S.G.	Roma	Scala	Longa
Archiade	Flaminia	G.S.I.	Garda	Scala	Primavera
Archiade	Fulvia	G.S.I.	Giada	Scala	Rugiada
Artigianato Ceramico	Duna	G.S.I.	Iseo	Scala	Tau
Artigianato Ceramico	Ghibli	G.S.I.	Lugano	Senesi	Brunello
Artigianato Ceramico	Oasi	G.S.I.	Modo	Senesi	Leonardo
Astra	Impero MB	G.S.I.	Topazio	Senesi	Michelangelo
Astra	Olimpia	Galassia	Olà	Senesi	Donatello
Axa	Mirto	Galassia	Vera	Simas	Alfa
Azzurra	Alba	Globo	Arianna	Simas	Beta
Azzurra	Giove	Gravena	Derby	Simas	Deborah
Catalano	Luce	Gravena	Jenny	Simas	Eco
Ceramica Cielo	Ermes	Hatria-Spea	Amalfi	Simas	Gatteo
Cesabo	Alexandra	IdealStandard	Ponti	Simas	Montezuma
Cesabo	Alessandro	Ilca	Micene	Sole	Egeo
Cesabo	Elite	Ilca	Tebe	Tenax-Simi	Airone
Cesame	Simplex	Incea	Supra	Tenax-Simi	Vega
Cierre	Ortisei	Olympia	Ambra	Vincenti	Milano
Delta	Oceano New	PozziGinori	Arcobaleno	Vitruvit-Profilo	Calipso
Delta	Raffaello	PozziGinori	Aura	Vitruvit-Profilo	Lady
Duravit	Architec	PozziGinori	Aurora	Vitruvit-Profilo	Minerva
Duravit	Darling	PozziGinori	Cervinia	Vitruvit-Profilo	Partenone
Duravit	Duraplus	PozziGinori	Curva	Vitruvit-Profilo	Partenone MB
Duravit	Laconda	PozziGinori	Elios	Vitruvit-Profilo	Sky3
Duravit	Speciale	PozziGinori	Europa	Vitruvit-Profilo	Sprint
Eos-Simca	Cimino	PozziGinori	Fantasia		
Eos-Simca	Jolly	PozziGinori	Gardena		
Eos-Simca	Orchidea	PozziGinori	Ginepro		
Eos-Simca	Tulipano	PozziGinori	Idro		
Etruria	Sirio	PozziGinori	Modulo		
Euroceramiche	Iris	PozziGinori	Selnova		
Falerii	Gaia	PozziGinori	Selva		
Falerii	Novella	PozziGinori	Tabor		
Falerii	Sabrina	PozziGinori	Torcello		
Flaminia	Arena	Rak	Karla		
Flaminia	Pompei	Roca	Neo Victoria		

Sedile wc in termoindurente  
Duroplast toilet seat

**BILBAO**

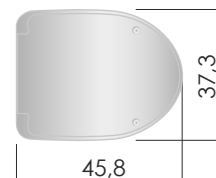
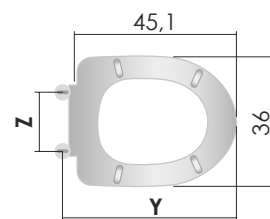

Kg. 2,270	Kg. 2,600	m <sup>3</sup> 0,0120	3 pcs Slow close	5 pcs	3 pcs 5 pcs
			Kg. 8,200	Kg. 13,800	m <sup>3</sup> 0,038 m <sup>3</sup> 0,070

	<b>H011</b>	<b>Cod. 2FSE032602</b>	Y = da 43,5 a 45,5 Z = da 13,5 a 18,5	Nylon Nylon	
	<b>H050</b>	<b>Cod. 2FSE205702</b>	Y = da 42 a 47 Z = da 9,3 a 19,3	Inox Stainless steel	
	<b>H481</b>	<b>Cod. 2FSE033402</b>	Y = da 41,5 a 47,5 Z = da 8,5 a 20,5	Nylon metallo Nylon metal	

Adattabilità principali  
Main adaptability





Azzurra	Full 56	Falerii	Victoria	Hidra	Loft
Delta	Smart	Galassia	Princes	Valadares	Oceanus MB

Sedile wc in termoindurente  
Duroplast toilet seat

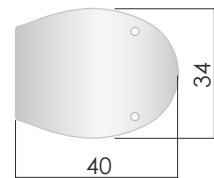
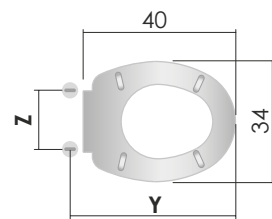

**BIMBO**



				
Kg. 1,350	Kg. 1,520	m <sup>3</sup> 0,0090	5 pcs Kg. 8,260	5 pcs m <sup>3</sup> 0,045



H011

Cod. 2FSE002102

Y = da 38 a 40,6  
Z = da 12,4 a 17,1

Nylon  
Nylon



Adattabilità principali  
Main adaptability

Dolomite





Asilo

Sedile wc in termoindurente  
Duroplast toilet seat

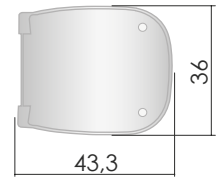
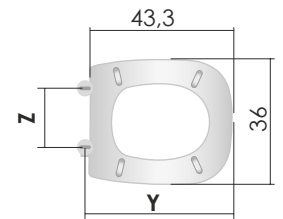

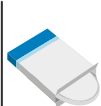
D-CODE



				
Kg. 2,200	Kg. 2,400	m <sup>3</sup> 0,0120	5 pcs Kg. 12,650	5 pcs m <sup>3</sup> 0,070



D-CODE

Cod. 2FSE055002

Y = da 42,2  
Z = da 16,8

Inox  
Stainless  
steel



Adattabilità principali  
Main adaptability

Duravit





D-Code

Sedile wc in termoindurente  
Duroplast toilet seat

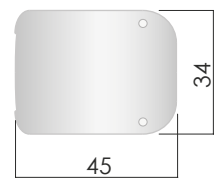
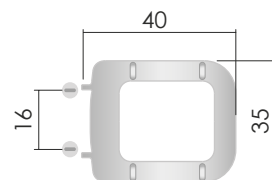

**DOUBLE** adatto a Conca



				
Kg. 2,100	Kg. 2,150	m <sup>3</sup> 0,0120	4 pcs	4 pcs
			Kg. 8,600	m <sup>3</sup> 0,070



**NYLON**

**Cod. 2FSE192402**

Y = da ceramica  
Z = 16

Nylon  
Nylon



**METALLO**

**Cod. 2FSE183702**

Y = da ceramica  
Z = 16

Metallo  
Metal



Adattabilità principali  
Main adaptability





Artigianato Ceramico	Rex	G.S.I.	Traccia	Scic	Maxi lusso
Cierre Sanitari	Cortina	Gravena	Conny	Senesi	Duccio
Cesabo	Prestige	Hidra	Montreal	Vincenti	Versilia
Etruria	Etruria	Ideal Standard	Conca	Vitruvit-Profil	Florida MB
Euroceramiche	Gioia	Isvea	C.O.	Vitruvit-Profil	Gronda
Falerii	Medina	Nero Ceramica	Aliseo	Vitruvit-Profil	Pella
G.S.I.	Vela	Nero Ceramica	Aliso sospeso		

Sedile wc in termoindurente  
Duroplast toilet seat

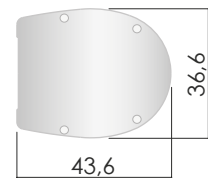
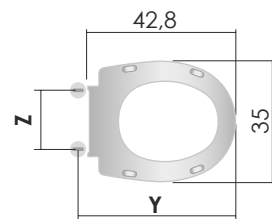

**DYNASTY**



				
Kg. 2,200	Kg. 2,250	m <sup>3</sup> 0,0120	5 pcs	5 pcs
			Kg. 12,000	m <sup>3</sup> 0,070



H050

Cod. 2FSE192202

Y = da 40 a 45  
Z = da 11 a 21

Inox  
Stainless  
steel







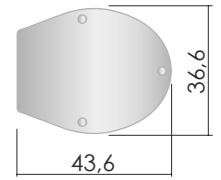
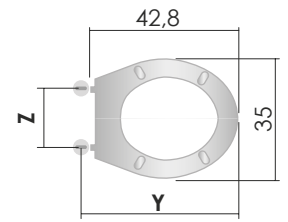

Adattabilità principali  
Main adaptability

Catalano	Zero light 50	Globo	New Arianna	Galassia	Eden
Globo	Diva	Scala	Meridiana	Ideal Standard	Tonda

Sedile wc in termoindurente  
Duroplast toilet seat

ECCO



				
Kg. 1,800	Kg. 2,015	m <sup>3</sup> 0,0109	5 pcs Kg. 10,600	5 pcs m <sup>3</sup> 0,070



H507

Cod. 2FSE037402

Y = da 42 a 47  
Z = da 10,5 a 20,5

Inox  
Stainless  
steel



Adattabilità principali  
Main adaptability

Ideal Standard	Gemma	Scala	Gemma
----------------	-------	-------	-------



Sedile wc in termoindurente  
Duroplast toilet seat



**FIVE** adatto a Tesi

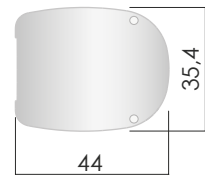
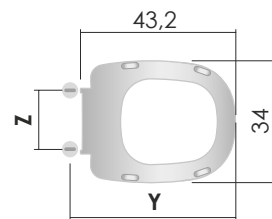

Kg. 1,940	Kg. 2,140	m <sup>3</sup> 0,0120	3 pcs Slow close	5 pcs	3 pcs 5 pcs
			Kg. 7,000	Kg. 11,640	m <sup>3</sup> 0,038 m <sup>3</sup> 0,070



**H025S**

**Cod. 2FSE172702**

Y = da 42 a 43,1  
Z = da 15,5 a 16,5

Inox  
Stainless  
steel



**H306**

**Cod. 2FSE172802**

Y = da 41,5 a 43,5  
Z = da 12 a 18

Nylon  
Nylon



Adattabilità principali  
Main adaptability

Cifal	Eden	Laufen	Mimo	Senesi	Pienza
G.S.I.	X2	Sanex	Tania	Vincenti	Curva
Ideal Standard	Tesi				

Sedile wc in termoindurente  
Duroplast toilet seat



HELP

Cod. 2FSE204302

Y = da 42,8 a 47,8  
Z = da 12,5 a 17,5

Inox  
Stainless  
steel



## HELP

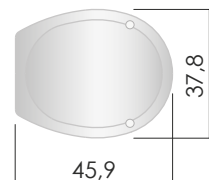
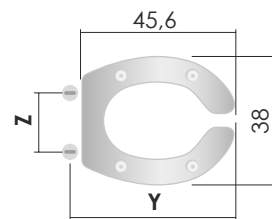

Kg. 2,700	Kg. 2,880	m <sup>3</sup> 0,0120	5 pcs Kg. 14,400	5 pcs m <sup>3</sup> 0,070

## HELP solo anello



HELP

Cod. 2FSE204402

Y = da 42,8 a 47,8  
Z = da 12,5 a 17,5

Inox  
Stainless  
steel



Adattabilità principali  
Main adaptability

Adatto alle ceramiche per disabili

Sedile wc in termoindurente  
Duroplast toilet seat



**KING**

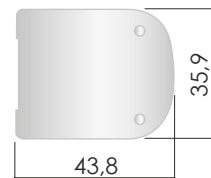
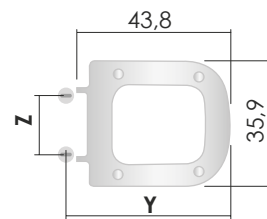

Kg. 2,245	Kg. 2,465	m <sup>3</sup> 0,0109	5 pcs	5 pcs
			Kg. 13,070	m <sup>3</sup> 0,070

	<b>H057</b>	<b>Cod. 2FSE033802</b>	Y = da 40,5 a 44,5 Z = da 15,5 a 19,5	Inox Stainless steel	
	<b>H050</b>	<b>Cod. 2FSE032802</b>	Y = da 40 a 45 Z = da 11,3 a 21,3	Inox Stainless steel	
	<b>H481</b>	<b>Cod. 2FSE033102</b>	Y = da 39,5 a 45,5 Z = da 10,3 a 22,3	Nylon metallo Nylon metal	

Adattabilità principali  
Main adaptability

Vitra

S20

## Sedile wc in termoindurente Duroplast toilet seat

## LIPS

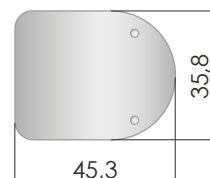
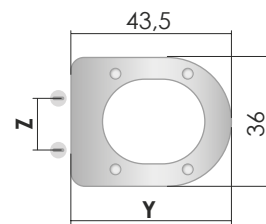

Kg. 2,290	Kg. 2,740	m <sup>3</sup> 0,0120	5 pcs	5 pcs
			Kg. 14,500	m <sup>3</sup> 0,070

	<b>H050</b>	<b>Cod. 2FSE040102</b>	Y = da 41,4 a 46,4 Z = da 11 a 21,1	Inox Stainless steel				
	<b>H057</b>	<b>Cod. 2FSE040202</b>	Y = da 43,5 a 46 Z = da 14,5 a 18,5	Inox Stainless steel				
	<b>H481</b>	<b>Cod. 2FSE040002</b>	Y = da 40,6 a 47,1 Z = da 8,7 a 21,5	Nylon metallo Nylon metal				
	<b>H482</b>	<b>Cod. 2FSE040802</b>	Y = da 40,6 a 47,1 Z = da 8,7 a 21,5	Nylon metallo Nylon metal				

## Adattabilità principali Main adaptability

Catalano	Sphera	G.S.I.	Norm	Azzurra	Comoda
Globo	Forty3	Flaminia	App	Roca	New Meridian
G.S.I.	Kubex	Hidra	Venus	Roca	Nexo
G.S.I.	Pure	Duravit	Stark		

Sedile wc in termoindurente  
Duroplast toilet seat



LUNA

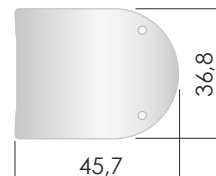
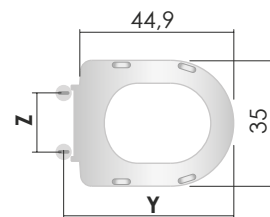

Kg. 2,310	Kg. 2,530	m <sup>3</sup> 0,0109	5 pcs	5 pcs
			Kg. 13,590	m <sup>3</sup> 0,070

	<b>H019</b>	<b>Cod. 2FSE008302</b>	Y = da 43,3 a 46,2 Z = da 14 a 20	Nylon Nylon			
	<b>H057</b>	<b>Cod. 2FSE165802</b>	Y = da 42,8 a 47,2 Z = da 16 a 20,2	Inox Stainless steel			
	<b>H050</b>	<b>Cod. 2FSE009302</b>	Y = da 42,5 a 47,7 Z = da 11,7 a 22,2	Inox Stainless steel			

Adattabilità principali  
Main adaptability

Olympia	Federica	Olympia	Serie 92	Olympia	Vela
Olympia	Rubino 1	Olympia	Serie 92 sospesa	Olympia	Vela 2
Olympia	Rubino 2	Olympia	Vaso c/esalatore	Olympia	Vogue

## LUNA 2

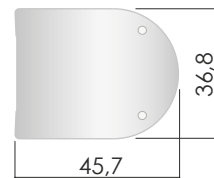
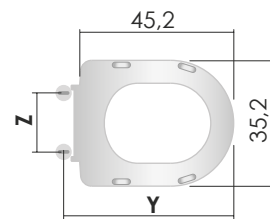

Kg. 2,300	Kg. 2,520	m <sup>3</sup> 0,0109	3 pcs Slow close	5 pcs	3 pcs 5 pcs
			Kg. 8,200	Kg. 13,540	m <sup>3</sup> 0,038 m <sup>3</sup> 0,070

	<b>H011</b>	<b>Cod. 2FSE194202</b>	Y = da 44 a 46 Z = da 14,8 a 20,3	Nylon Nylon	
	<b>H057</b>	<b>Cod. 2FSE202802</b>	Y = da 42,8 a 47,2 Z = da 16 a 20,2	Inox Stainless steel	
	<b>H050</b>	<b>Cod. 2FSE000502</b>	Y = da 42,5 a 47,7 Z = da 10,7 a 20,7	Inox Stainless steel	
	<b>H306</b>	<b>Cod. 2FSE000702</b>	Y = da 44 a 46 Z = da 14,8 a 20,3	Nylon Nylon	
	<b>H323</b>	<b>Cod. 2FSE000802</b>	Y = da 42,3 a 47,3 Z = da 11,1 a 21,1	Metallo cromato Metal chrome	

**Cod. 2FSE202802 (H057)**

Althea (Sanitalia)	Althea	Cesame	Sintesi	Gravena	Garbo
Althea (Sanitalia)	Marea	Cesame	Sintesi sospeso	Hatria-Spea	Dolcevita
Althea (Sanitalia)	Marion	Cesame	System	Hidra	Pluvia
Althea (Sanitalia)	Melrose	Cierre Sanitari	Dea	Hidra	Top Line
Althea (Sanitalia)	Ring	Cierre Sanitari	Okay 2 sospesa	Incea	Sara
Amerina	Arco	Delta	Gea	Indusa	Alfa
Amerina	Armony	Delta	Navona	Jumbo	Renoire
Archiade	Marina	Delta	Sahara	Jumbo	Simpaty
Artigianato Ceramico	Croma	Delta	Solara	Kerafina	Fryni
Astra	Divina	Eos-Simca	Antaga	Kerafina	Narkios
Astra	Serie 84	Euroceramiche	Valentina	Kerasan	Mantego
Astra	Serie 85	Falerii	Tiffany	Olympia	Rio
Astra	Clivia	Flaminia	Fidia	Sanindusa	Alpha
Astra	Sicilia	Flaminia	Fidia vecchio	Sanindusa	Prestige
Astra	Verbena	Flaminia	Link	Sbordoni	Marina
Azzurra	Divina	Flaminia	Mini link	Scic	Bella
Azzurra	Frine	Flaminia	Relax	Scic	Donna
Azzurra	I Sensi	Flaminia	Relax sospesa	Scic	L'altra Linea
Azzurra	Paola	Flaminia	Valentine Nuovo	Senesi	Tosca
Azzurra	Venere	Galassia	Aster	Tenax-simi	Geo
Catalano	Canova	G.S.G.	Astra	Vavid	Tebe
Catalano	Odeon	G.S.G.	Jasmine	Vellero	Odissesa
Catalano	Visa	G.S.I.	Avant	Vincenti	Tipo
Ceramica Cielo	Ares	G.S.I.	Blitz	Vitra	S50
Ceramica Cielo	Celia	G.S.I.	Elisa	Vitruvit-Profilo	Fantasia
Ceramica Cielo	Florence	G.S.I.	Pitti	Vitruvit-Profilo	Stella
Cesabo	Endurance	Globo	Alia		

**Cod. 2FSE000802 (H323)**

Althea (Sanitalia)	Althea	Astra	Sicilia	Ceramica Cielo	Ares
Althea (Sanitalia)	Marea	Astra	Verbena	Ceramica Cielo	Celia
Althea (Sanitalia)	Marion	Azzurra	Nuvola	Ceramica Cielo	Florence
Althea (Sanitalia)	Melrose	Azzurra	Divina	Cesabo	Endurance
Althea (Sanitalia)	Ring	Azzurra	Frine	Cesame	Sintesi Sospesa
Amerina	Arco	Azzurra	I Sensi	Cesame	System
Amerina	Armony	Azzurra	Link	Cierre Sanitari	Dea
Archiade	Sospesa	Azzurra	Paola	Cierre Sanitari	Okay 2 sospesa
Archiade	Marina	Azzurra	Venere	Delta	Navona
Artigianato Ceramico	Croma	Catalano	Canova	Delta	Sahara
Astra	Divina	Catalano	Odeon	Delta	Solara
Astra	Serie 84	Catalano	Free	Disegno Ceramica	Skip
Astra	Serie 85	Catalano	Visa		
Astra	Clivia	Ceramica Cielo	Smile		

**Cod. 2FSE000802 (H323)**

Dolomite	Alpina	G.S.I.	Giulia	Olympia	Vela
Dolomite	Clodia	G.S.I.	Pitti	Olympia	Vela 2
Dolomite	Clodia MB	G.S.I.	Community	Olympia	Vogue
Dolomite	Quadrarco	Gravena	Garbo	Pozzi Ginori	Atena
Dolomite	RC 80	Hatria-Spea	Daytime	Pozzi Ginori	Linea
Duravit	Dellarco	Hatria-Spea	Dolcevita	Pozzi Ginori	Ydra
Duravit	Erica	Hatria-Spea	Marylin	Rak	Compact
Duravit	Vienna	Hidra	Pluvia	Roca	Nexo
Eos-Simca	Antaga	Hidra	Pluvia Sospeso	Roca	Tipo
Eos-Simca	Punto	Hidra	Top Line	Sanindusa	Alpha
Eos-Simca	Riace-Segesta	Ideal Standard	Esedra	Sanindusa	Prestige
Esedra	Ever	Ideal Standard	Fiorile Sospeso	Sbordoni	Marina
Euroceramiche	Valentina	Ideal Standard	Fiorile Lusso	Scic	Bella
Falerii	Chiara	Ideal Standard	Fiorile New	Scic	Donna
Falerii	Tiffany	Ideal Standard	Linda	Scic	L'altra Linea
Flaminia	Link	Ideal Standard	Moderno	Senesi	Tosca
Flaminia	Relax	Ideal Standard	Wash Point	Senesi	Tuscia
Flaminia	Relax sospesa	Incea	Sara	Tenax-Simi	Geo
Flaminia	Valentine Nuovo	Indusa	Alfa	Vavid	Tebe
Flaminia	Void	Jumbo	Renoire	Veliero	Odissesa
Globo	Open Space	Jumbo	Simpaty	Villeroy & Boch	Alpina
Globo	Concept	Kerafina	Fryni	Villeroy & Boch	Magnum
Globo	Alia	Kerafina	Narkios	Vincenti	Tipo
Globo	Misura 1	Kerasan	Montego	Vitra	S50
G.S.G.	Astra	Olympia	Federica	Vitruvit-Profilii	Fantasia
G.S.G.	Jasmine	Olympia	Rio	Vitruvit-Profilii	Stella
G.S.I.	Avant	Olympia	Rubino 1	Vitruvit-Profilii	Armonia
G.S.I.	Blitz	Olympia	Rubino 2	Vulcano	Classia
G.S.I.	Dafne	Olympia	Serie 92		
G.S.I.	Desy	Olympia	Serie 92 sospesa		
G.S.I.	Elisa	Olympia	Vaso c/esalatore		

**Cod. 2FSE000502 (H050)**

Archiade	Sospesa	Eos-Simca	Punto	Ideal Standard	Moderno
Azzurra	Nuvola	Eos-Simca	Riace-Segesta	Ideal Standard	Wash Point
Catalano	Free	Esedra	Ever	Pozzi Ginori	Ydra
Ceramica Cielo	Smile	Flamina	Void	Rak	Compact
Disegno Ceramica	Skip	Globo	Open Space Concept	Roca	Nexo
Dolomite	Alpina	G.S.I.	Community	Roca	Tipo
Dolomite	Clodia	Hatria-Spea	Daytime	Senesi	Tuscia
Dolomite	Clodia MB	Ideal Standard	Fiorile Sospeso	Villeroy & Boch	Alpina
Dolomite	Quadrarco	Ideal Standard	Fiorile Lusso	Villeroy & Boch	Magnum
Duravit	Dellarco	Ideal Standard	Fiorile New	Vitruvit-Profilii	Armonia
Duravit	Erica	Ideal Standard	Linda	Vulcano	Classia
Duravit	Vienna				



Sedile wc in termoindurente  
Duroplast toilet seat



**MATCH**

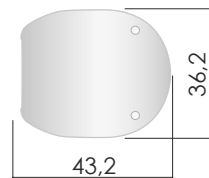
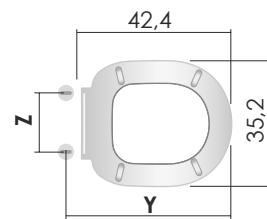

Kg. 2,200	Kg. 2,550	m <sup>3</sup> 0,0120	5 pcs Slow close	5 pcs	5 pcs
			Kg. 13,400	Kg. 13,400	m <sup>3</sup> 0,070



**H050**

**Cod. 2FSE202002**

Y = da 39,5 a 44,5  
Z = da 10 a 20

Inox  
Stainless  
steel



**H481**

**Cod. 2FSE209202**

Y = da 38,5 a 44,5  
Z = da 10 a 20

Nylon  
metallo  
Nylon  
metal



Adattabilità principali  
Main adaptability





Ideal Standard



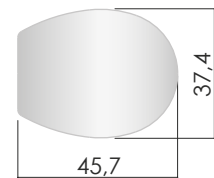
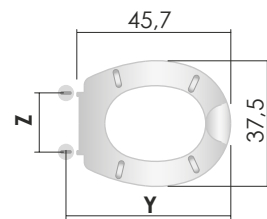



Connect

Sedile wc in termoindurente  
Duroplast toilet seat

MITHO



				
Kg. 1,970	Kg. 2,190	m <sup>3</sup> 0,0109	Kg. 12,000 5 pcs	m <sup>3</sup> 0,070 5 pcs

	<b>H011</b>	<b>Cod. 2FSE002202</b>	Y = da 43,6 a 45,3 Z = da 12,8 a 18,4	Nylon Nylon	
	<b>H019</b>	<b>Cod. 2FSE004902</b>	Y = da 43,5 a 46,4 Z = da 11,8 a 17,8	Nylon Nylon	 
	<b>H057</b>	<b>Cod. 2FSE002402</b>	Y = da 43,3 a 47 Z = da 13,4 a 17,9	Inox Stainless steel	

Adattabilità principali  
Main adaptability

**Cod. 2FSE002202 (H011)**

Gravena	Rhonda	Sbordoni	Fabia	Scala	Tanga
Ideal Standard	Liuto				

**Cod. 2FSE002402 (H057)**





Eos-Simca	Mistral	Ideal Standard	Liuto	Scala	Tanga
Gravena	Rhonda	Sbordoni	Fabia		

Sedile wc in termoindurente  
Duroplast toilet seat

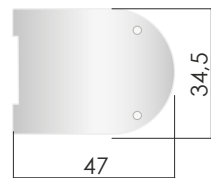
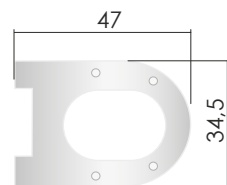

## PANCARE/CARENA



				
Kg. 3,160	Kg. 3,600	m <sup>3</sup> 0,0106	4 pcs Kg. 17,060	4 pcs m <sup>3</sup> 0,066



PANCARE

Cod. 2FSE197102

N.D.

Metallo e nylon  
Metal & nylon

Adattabilità principali  
Main adaptability

Ceramiche Cidneo

Pancare - Carena

## PASSEPARTOUT

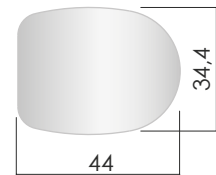
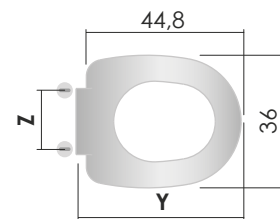

Kg. 2,100	Kg. 2,320	m <sup>3</sup> 0,0109	3 pcs Slow close	5 pcs	3 pcs 5 pcs
			Kg. 7,500	Kg. 12,455	m <sup>3</sup> 0,038 m <sup>3</sup> 0,070

	<b>H011</b>	<b>Cod. 2FSE161402</b>	Y = da 42,8 a 44,6 Z = da 12,6 a 18,3	Nylon Nylon	
	<b>H057</b>	<b>Cod. 2FSE164602</b>	Y = da 41,8 a 45,7 Z = da 13,3 a 17,8	Inox Stainless steel	
	<b>H050</b>	<b>Cod. 2FSE166402</b>	Y = da 40,9 a 46,3 Z = da 9,3 a 19,4	Inox Stainless steel	
	<b>H025</b>	<b>Cod. 2FSE164902</b>	Y = da 43,1 a 43,9 Z = da 15 a 16	Inox Stainless steel	
	<b>H306</b>	<b>Cod. 2FSE175402</b>	Y = da 42,8 a 44,6 Z = da 12,6 a 18,3	Nylon Nylon	
	<b>H323</b>	<b>Cod. 2FSE175502</b>	Y = da 41,6 a 46,3 Z = da 8,7 a 18,8	Metallo cromato Metal chrome	

**Cod. 2FSE166402 (H050)**

Azzurra	Afrodite	Flaminia	Sprint sospeso	Rak	Washington
Azzurra	Elios Plus	G.S.I.	Davina	Scanitosco	004Open01
Azzurra	Minerva	G.S.I.	Fedra	Scic	Kappa
Catalano	Neve	Galvid	Mirò	Simas	Arcade
Catalano	Neve New	Globo	Grace Filo Parete	Simas	Europa 2 vers.
Cesame	Belle Epoque	Gravena	Croma	Tenax-Simi	Alba
Cierre Sanitari	Okay 2	Hidra	Memory	Tenax-Simi	Gabbiano
Delta	Futura	Isvea	Monika	Vincenti	Antica
Delta	Golf	Kerafina	Millenium	Vitruvit-Profilii	Alessandra
Disegno Ceramica	Giulia	Pozzi Ginori	Easy	Vitruvit-Profilii	Maiorca
Dolomite	Garda	Pozzi Ginori	Quinta	Vulcano	Primavera
Eos-Simca	Orion	Pozzi Ginori	Selnova 3		
Eos-Simca	Punto Sospesa	Rak	Metropolitan		

**Cod. 2FSE164602 (H057)**

Althea (Sanitalia)	Elena	Eos-Simca	Clio	Hidra	Angela
Catalano	Acqua	Flamina	Metro sospesa	Indusa	Aveiro
Catalano	Aria Nuovo	G.S.I.	Xenia 1	Laufen	Dino Sospesa
Cesame	900	Galassia	Piuma	Pozzi Ginori	Selnova 3
Cesame	Aretusa Sospesa	Galvit	Agorà	Rak	Orient
Cesame	Aretusina	Gravena	Gaia		
Cesame	Aretusina MB	Gravena	Giada		

**Cod. 2FSE175502 (H323)**

Althea (Sanitalia)	Elena	Eos-Simca	Punto Sospesa	Ideal Standard	Moderno
Azzurra	Afrodite	Eos-Simca	Riace-Segesta	Isvea	Monika
Azzurra	Elios Plus	Flaminia	Sprint sospeso	Kerafina	Millenium
Azzurra	Minerva	Flaminia	Metro sospesa	Pozzi Ginori	Easy
Catalano	Acqua	G.S.I.	Community	Pozzi Ginori	Quinta
Catalano	Aria Nuovo	G.S.I.	Davina	Pozzi Ginori	Selnova 3
Catalano	Aretusa Sospesa	G.S.I.	Fedra	Rak	Orient
Catalano	Aretusina	G.S.I.	Xenia 1	Rak	Washington
Catalano	Aretusina MB	Galassia	Piuma	Sanitosco	004 Open 01
Catalano	Neve	Galvit	Agorà	Scic	KAppa
Catalano	New Neve	Galvit	Mirò	Senesi	Tuscia
Cesame	Belle Epoque	Globo	Grace Filo Parete	Simas	Arcade
Cierre Sanitari	Okay 2	Gravena	Croma	Simas	Europa 2 vers.
Delta	Futura	Gravena	Gaia	Tenax-Simi	Alba
Delta	Golf	Gravena	Giada	Tenax-Simi	Gabbiano
Disegno Ceramica	Giulia	Indusa	Aveiro	Vincenti	Antica
Dolomite	Garda	Laufen	Dino Sospesa	Vitruvit-Profilii	Alessandra
Eos-Simca	Clio	Hidra	Memory	Vitruvit-Profilii	Maiorca
Eos-Simca	Orion	Ideal Standard	Fiorile Sospeso	Vitruvit-Profilii	Young
Eos-Simca	Punto	Ideal Standard	Linda	Vulcano	Primavera

Sedile wc in termoindurente  
Duroplast toilet seat



PENTA

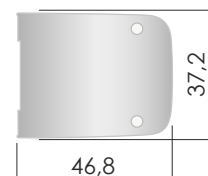
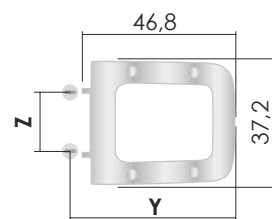

Kg. 2,520	Kg. 2,770	m <sup>3</sup> 0,0109	5 pcs	5 pcs
			Kg. 14,200	m <sup>3</sup> 0,070



H050

Cod. 2FSE032702

Y = da 43 a 49  
Z = da 10 a 20

Inox  
Stainless  
steel



H481

Cod. 2FSE034802

Y = da 43,5 a 48,5  
Z = da 11 a 21

Nylon  
metallo  
Nylon  
metal



Adattabilità principali  
Main adaptability

Blumfeldt

Lamera

Sedile wc in termoindurente  
Duroplast toilet seat



QUEEN

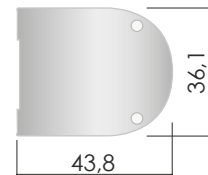
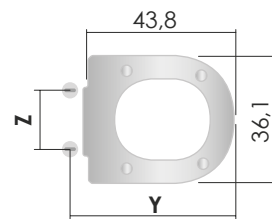

Kg. 2,520	Kg. 2,770	m <sup>3</sup> 0,0109	5 pcs Kg. 14,200	5 pcs m <sup>3</sup> 0,070

	<b>H050</b>	<b>Cod. 2FSE032902</b>	Y = da 40 a 45 Z = da 11 a 21	Inox Stainless steel	
	<b>H481</b>	<b>Cod. 2FSE033002</b>	Y = da 39,5 a 45,5 Z = da 10 a 22	Nylon metallo Nylon metal	

Adattabilità principali  
Main adaptability

Alice Ceramica	Hide round	Flaminia	App	Hidra	Tour 4.0
Catalano	Visa	Flaminia	Link	Jumbo	Renoire
Catalano	New Zero	Flaminia	Quick	Laufen	Object
Catalano	Sfera	Globo	Mode	Rak	Resort
Delta	Navona	Hidra	Pluvia sospeso	Villeroy&Boch	Subway

# RODEO

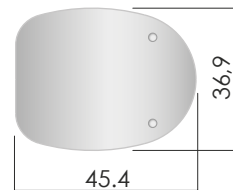
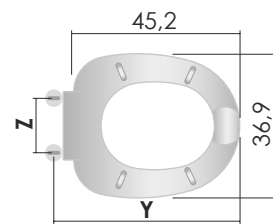

Kg. 2,260	Kg. 2,485	m <sup>3</sup> 0,0109	3 pcs Slow close	5 pcs	3 pcs 5 pcs
			Kg. 8,000	Kg. 13,315	m <sup>3</sup> 0,038 m <sup>3</sup> 0,070





	<b>H011</b>	<b>Cod. 2FSE162502</b>	Y = da 43,2 a 45,0 Z = da 11,9 a 18,1	Nylon Nylon	
	<b>H057</b>	<b>Cod. 2FSE172402</b>	Y = da 42,3 a 46,1 Z = da 12,9 a 17,3	Inox Stainless steel	
	<b>H050</b>	<b>Cod. 2FSE172302</b>	Y = da 41,7 a 46,2 Z = da 9,9 a 18,6	Inox Stainless steel	
	<b>H306</b>	<b>Cod. 2FSE193502</b>	Y = da 43,2 a 45 Z = da 11,9 a 18,1	Nylon Nylon	



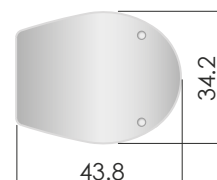
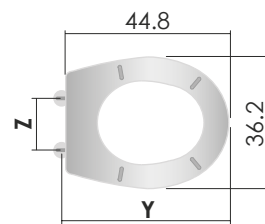





Althea (Sanitalia)	Cora	Cierre Sanitari	Piuma	Hidra	Onda
Althea (Sanitalia)	Plaza	Cierre Sanitari	Super	Hidra	Pegaso
Althea (Sanitalia)	Rose	Duravit	Nube	Jumbo	Aretha
Astra	Gemma	Eos - Simca	Armonia	Jumbo	Arethona
Astra	Hi-fi	Eos - Simca	Astro	Jumbo	Tua
Astra	Mia	Eos - Simca	Flower	Kerafina	Lito
Astra	Serie 83	Eos - Simca	Ola	Kerafina	Vergina
Axa	Axa2	Etruria	Alba	Kerasan	Elka
Azzurra	Afrodite	Falerii	Adria	Kerasan	Godia
Azzurra	Diana	Falerii	Aida	Roca	Zoom
Azzurra	Elena	Falerii	Giulietta	Sbordoni	Sospesa
Azzurra	Elios	Flaminia	Isabel	Senesi	Sovana
Azzurra	Giulia MB	Flaminia	Metro	Simas	Primavera
Azzurra	Le Onde	Flaminia	Spin	Simas	Selenia
Azzurra	Midas	G.S.G.	Ambra	Sole	Elisa
Azzurra	Novecento	Globo	Flavia (Alia)	Vavid	Orientale
Azzurra	Ottocento	Globo	Grace	Vincenti	Farah
Cierre Sanitari	Desirée	Globo	Open Space	Vincenti	Uno
Cierre Sanitari	Okay	Gravena	Pendy		

## SAMBA



				
Kg. 1,630	Kg. 1,850	m <sup>3</sup> 0,0109	5 pcs	5 pcs
			Kg. 10,050	m <sup>3</sup> 0,070

	<b>H011</b>	<b>Cod. 2FSE007402</b>	Y = da 42,7 a 45,0 Z = da 13 a 17,9	Nylon Nylon	
	<b>H057</b>	<b>Cod. 2FSE158602</b>	Y = da 42,4 a 45,7 Z = da 14,1 a 18,7	Inox Stainless steel	
	<b>H025</b>	<b>Cod. 2FSE009402</b>	Y = da 43,4 a 44,6 Z = da 15,5 a 16,5	Inox Stainless steel	

**Cod. 2FSE007402 (H011)**

Catalano	Taormina	Pozzi Ginori	Cervino	Sbordoni	Flavia
Dolomite	Cristallo	Pozzi Ginori	Colibrì	Sbordoni	Kerafin
Dolomite	Quarzo	Pozzi Ginori	Ilgarda	Scala	Gemma
Eos-Simca	Medea	Pozzi Ginori	Kim	Simas	Lory
Falerii	Thermae	Pozzi Ginori	Monviso	Vitra	Architect sospeso
Keramag	Koblenz	Roca	Polo	Vitruvit-Profilì	Diana
Laufen	Lyra	Roca	Victoria		





**Cod. 2FSE158602 (H057)**



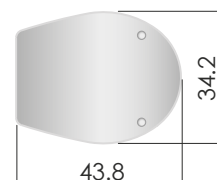
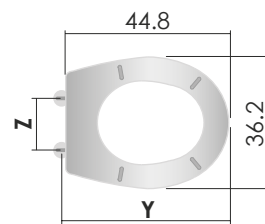



Catalano	Taormina	Pozzi Ginori	Cervino	Sbordoni	Flavia
Dolomite	Cristallo	Pozzi Ginori	Colibrì	Sbordoni	Kerafin
Dolomite	Quarzo	Pozzi Ginori	Ilgarda	Scala	Gemma
Eos-Simca	Medea	Pozzi Ginori	Kim	Simas	Lory
Falerii	Thermae	Pozzi Ginori	Monviso	Vitra	Architect sospeso
Incea	Nube	Roca	Polo	Vitruvit-Profilì	Diana
Keramag	Koblenz	Roca	Victoria		
Laufen	Lyra				

Sedile wc in termoindurente  
Duroplast toilet seat

## SEBINO



				
Kg. 1,400	Kg. 1,625	m <sup>3</sup> 0,0109	5 pcs	5 pcs
			Kg. 9,010	m <sup>3</sup> 0,070

	<b>H011</b>	<b>Cod. 2FSE005902</b>	Y = da 42,7 a 45,0 Z = da 13 a 17,9	Nylon Nylon	
	<b>H057</b>	<b>Cod. 2FSE015902</b>	Y = da 42,4 a 45,7 Z = da 14,1 a 18,7	Inox Stainless steel	
	<b>H025</b>	<b>Cod. 2FSE165102</b>	Y = da 43,4 a 44,6 Z = da 15,5 a 16,5	Inox Stainless steel	

**Cod. 2FSE005902 (H011)**

**Cod. 2FSE015902 (H057)**





Catalano	Taormina	Pozzi Ginori	Cervino	Sbordoni	Flavia
Dolomite	Cristallo	Pozzi Ginori	Colibrì	Sbordoni	Kerafin
Dolomite	Quarzo	Pozzi Ginori	Ilgarda	Scala	Gemma
Eos-Simca	Medea	Pozzi Ginori	Kim	Simas	Lory
Falerii	Thermae	Pozzi Ginori	Monviso	Vitra	Architect sospeso
Keramag	Koblenz	Roca	Polo	Vitruvit-Profilì	Diana
Laufen	Lyra	Roca	Victoria		

Sedile wc in termoindurente  
Duroplast toilet seat

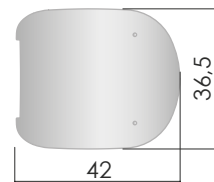
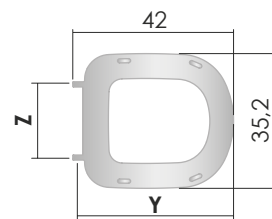

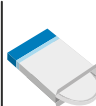
SIX



				
Kg. 1,950	Kg. 2,150	m <sup>3</sup> 0,0120	5 pcs	5 pcs
			Kg. 10,750	m <sup>3</sup> 0,070



TOP FIX

Cod. 2FSE037202

Y = 42,5  
Z = 15,5

Inox  
Stainless  
steel



SLOW CLOSE

Cod. 2FSE037302

Y = 42,5  
Z = 15,5

Nylon  
Nylon



Adattabilità principali  
Main adaptability

Ideal Standard

Tempo





Ideal Standard

Tesi Aquablade

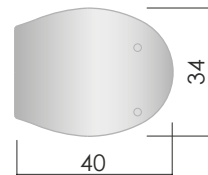
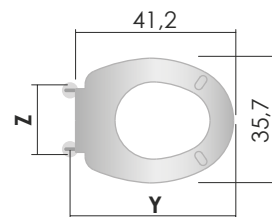
Sedile wc in termoindurente  
Duroplast toilet seat

SMALL



				
Kg. 1,420	Kg. 1,615	m <sup>3</sup> 0,0090	5 pcs	5 pcs
			Kg. 8,800	m <sup>3</sup> 0,045



H011

Cod. 2FSE004602

Y = da 38 a 40,6  
Z = da 12,4 a 17,1

Nylon  
Nylon



H050

Cod. 2FSE016502

Y = da 37,8 a 43,1  
Z = da 9,4 a 19,5

Inox  
Stainless  
steel



Adattabilità principali  
Main adaptability

Cod. 2FSE016502 (H050)

Axa	Round	Hidra	Smarty
Falerii	F-concept	Roca	Polo New

Sedile wc in termoindurente  
Duroplast toilet seat



**SPEED**

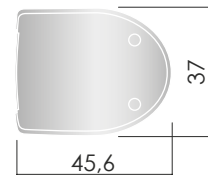
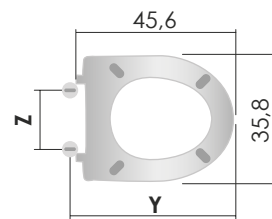

Kg. 2,260	Kg. 2,550	m <sup>3</sup> 0,0120	3 pcs Slow close	5 pcs	3 pcs 5 pcs
			Kg. 8,000	Kg. 13,500	m <sup>3</sup> 0,038 m <sup>3</sup> 0,070



H507

**Cod. 2FSE037002**

Y = da 42 a 47  
Z = da 13,2 a 23,2

Inox  
Stainless  
steel



H515

**Cod. 2FSE037102**

Y = da 42 a 47  
Z = da 13,2 a 23,2

Metallo  
cromato  
Metal  
chrome



Adattabilità principali  
Main adaptability

Pozzi Ginori

Fast

Pozzi Ginori





Selnova Pro



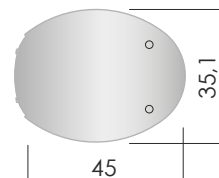
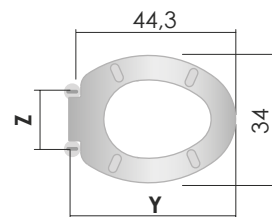









Sedile wc in termoindurente  
Duroplast toilet seat

## TANGO



				
Kg. 1,510	Kg. 1,730	m <sup>3</sup> 0,0109	5 pcs	5 pcs
			Kg. 9,490	m <sup>3</sup> 0,070

	<b>H011</b>	<b>Cod. 2FSE009602</b>	Y = da 42,7 a 44,7 Z = da 12,8 a 17,9	Nylon Nylon	
	<b>H025</b>	<b>Cod. 2FSE198602</b>	Y = da 41,8 a 45,6 Z = da 12,1 a 16,7	Inox Stainless steel	
	<b>H057</b>	<b>Cod. 2FSE172102</b>	Y = da 43,6 a 44,8 Z = da 14 a 15	Inox Stainless steel	
	<b>H050</b>	<b>Cod. 2FSE009702</b>	Y = da 41,3 a 44,7 Z = da 10,7 a 20,7	Inox Stainless steel	  

**Cod. 2FSE009602 (H011)**

**Cod. 2FSE172102 (H057)**

Althea	Sky	Flaminia	Nori	Jumbo	Golia
Artigianato Ceramico	Safari	Galassia	Ala	Kerasan	Europa
Astra	Impero	Galvit	Egira	Kerasan	Jolly
Astra	Lido	Globo	Arianna MB	Kerasan	Luna
Astra	Trio	Globo	Lei MB	Laufen	Dino
Azzurra	Aris	Hatria-Spea	Baia	Laufen	Gallery
Catalano	Junior	Hatria-Spea	Cannes	Laufen	Jika
Catalano	Dorica	Hatria-Spea	Edilizia	Pozzi Ginori	Mini
Catalano	Sila	Hatria-Spea	Erika	Pozzi Ginori	Murano
Catalano	Taormina	Hatria-Spea	Monaco	Pozzi Ginori	Torena
Cierre Sanitari	Leonessa	Hatria-Spea	Nizza	Sbordoni	Fausta
Delta	Caravaggio	Hidra	Athena	Scala	Iril
Delta	Delta	Hidra	Brasilia	Scic	Maxi Jolly
Delta	Michelangelo MB	Hidra	Nautilus Sospesa	Senesi	Balzana
Delta	Samba	Hidra	Record	Senesi	Donatello
Dolomite	Donatello	Hidra	Roma	Senesi	Guelfa
Dolomite	Perla Classic	Ideal Standard	Ellisse	Tenax-Simi	Tenax
Dolomite	Tenax	Ideal Standard	Ellisse Più	Vavid	Farnese
Eos-Simca	Primula	Ideal Standard	Zanvas (ponti Zeta)	Vavid	Partenopea
Eos-Simca	Stylon	Ilca	Itaca	Vincenti	Brava
Etruria	Arista	Ilca	Menfi	Vitra	Elena/Normus
Etruria	Conchiglia	Ilca	Vesuvio	Vitruvit-Profilii	Roma
Euroceramiche	Più	Isvea	Aventino		

Sedile wc in termoindurente  
Duroplast toilet seat

TERRA

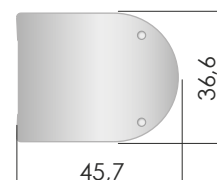
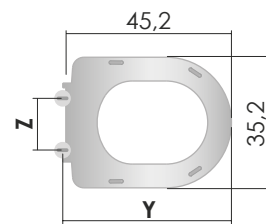

Kg. 2,370	Kg. 2,560	m <sup>3</sup> 0,0109	3 pcs Slow close	5 pcs	3 pcs 5 pcs
			Kg. 10,000	Kg. 16,650	m <sup>3</sup> 0,038 m <sup>3</sup> 0,070

	<b>H011</b>	<b>Cod. 2FSE016202</b>	Y = da 44,0 a 46,0 Z = da 14,8 a 20,3	Nylon Nylon	
	<b>H057</b>	<b>Cod. 2FSE193902</b>	Y = da 42,8 a 47,2 Z = da 16,0 a 20,2	Inox Stainless steel	
	<b>H050</b>	<b>Cod. 2FSE001602</b>	Y = da 42,5 a 47,7 Z = da 11,7 a 22,2	Inox Stainless steel	  
	<b>H306</b>	<b>Cod. 2FSE000602</b>	Y = da 44,0 a 46,0 Z = da 14,8 a 20,3	Nylon Nylon	 
	<b>H323</b>	<b>Cod. 2FSE001002</b>	Y = da 42,7 a 47,2 Z = da 11,2 a 21,2	Metallo cromato Metal chrome	  

Adattabilità principali  
Main adaptability

**Cod. 2FSE001602 (H050)**

**Cod. 2FSE001002 (H323)**

Dolomite	Petra	Ideal Standard	Perle	Roca	Meridian
Eos-Simca	Punto sospesa	Ideal Standard	Tonic	Villeroy & Boch	Basic
Flaminia	Link	Incea	Laura	Villeroy & Boch	Laura
Flaminia	App	Jumbo	Esatonda	Villeroy & Boch	Subway
Flaminia	Quick	Laufen	Object		
Ideal Standard	Absolute Kurokawa	Rak	Resort		

Sedile wc in termoindurente  
Duroplast toilet seat



VALENCIA

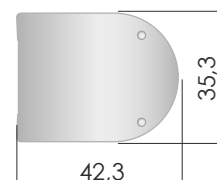
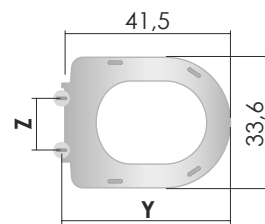

Kg. 2.500	Kg. 2.700	m <sup>3</sup> 0,0120	5 pcs Slow close	5 pcs	5 pcs
			Kg. 14,150	Kg. 14,150	m <sup>3</sup> 0,070

	<b>H050</b>	<b>Cod. 2FSE205902</b>	Y = da 38,7 a 43,7 Z = da 13,5 a 23,5	Inox Stainless steel				
	<b>H481</b>	<b>Cod. 2FSE209302</b>	Y = da 38,5 a 44,5 Z = da 11,5 a 23,5	Nylon metallo Nylon metal				

Adattabilità principali  
Main adaptability

Alice Ceramica	Form	Dolomite	Cristallo Nuovo	Galassia	Aster
Catalano	Visa	Esedra	Ever	Globo	Open spacee
Catalano	Sphera	Flaminia	Void	GSI	City Pro
Catalano	Zero 45	Flaminia	Fidia	Ideal Standard	Esedra
Catalano	Zero 55	G.S.I.	Norma	Simas	E-Line
Catalano	Visa	G.S.I.	Puma		
Ceramica Cielo	Smile				

Sedile wc in termoindurente  
Duroplast toilet seat

VIP

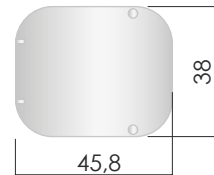
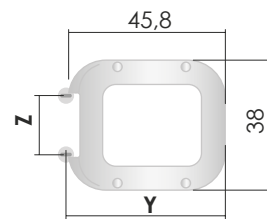

Kg. 2,330	Kg. 2,550	m <sup>3</sup> 0,0109	5 pcs Slow close	5 pcs	5 pcs
			Kg. 13,575	Kg. 13,575	m <sup>3</sup> 0,070



H050

Cod. 2FSE037602

Y = da 42,0 a 47,0  
Z = da 9,9 a 20,1

Inox  
Stainless  
steel



H481

Cod. 2FSE037702

Y = da 41,2 a 47,9  
Z = da 8,0 a 20,6

Nylon e  
metallo  
Nylon and  
metal



Adattabilità principali  
Main adaptability

Noken

Essence C

**SEDILI WC IN TERMOINDURENTE A FORMA UNIVERSALE  
UNIVERSAL SHAPED DUROPLAST WC SEATS**



## Principali ceramiche a forma universale Main universal-shaped ceramics





Althea(Sanitalia)	Cento	Falerii	Sabrina		
Althea(Sanitalia)	Hola	Flaminia	Arena	PozziGinori	Modulo
Archiade	Fausta	Flaminia		PozziGinori	Selnova
Archiade	Flaminia	PompeiG.S.G.	Alfa	PozziGinori	Selva
Archiade	Fulvia	G.S.G.	Atene	PozziGinori	Tabor
Artigianato Ceramico	Duna	G.S.G.	Roma	PozziGinori	Torcello
Artigianato Ceramico	Ghibli	G.S.I.	Garda	Rak	Karla
Artigianato Ceramico	Oasi	G.S.I.	Giada	Roca	Neo Victoria
Astra	Impero MB	G.S.I.	Iseo	Sbordoni	Flaminia
Astra	Olimpia	G.S.I.	Lugano	Scala	Friuli
Axa	Mirto	G.S.I.	Modo	Scala	Longa
Azzurra	Alba	G.S.I.	Topazio	Scala	Primavera
Azzurra	Giove	Galassia	Olà	Scala	Rugiada
Catalano	Luce	Galassia	Vera	Scala	Tau
Ceramica Cielo	Ermes	Globo	Arianna	Senesi	Brunello
Cesabo	Alexandra	Gravena	Derby	Senesi	Leonardo
Cesabo	Alessandro	Gravena	Jenny	Senesi	Michelangelo
Cesabo	Elite	Hatria-Spea	Amalfi	Simas	Alfa
Cesame	Simplex	IdealStandard	Ponti	Simas	Beta
Cierre	Ortisei	Ilca	Micene	Simas	Deborah
Delta	Oceano New	Ilca	Tebe	Simas	Eco
Delta	Raffaello	Incea	Supra	Simas	Gatteo
Duravit	Architec	Olympia	Ambra	Simas	Montezuma
Duravit	Darling	PozziGinori	Arcobaleno	Sole	Egeo
Duravit	Laconda	PozziGinori	Aura	Tenax-Simi	Airone
Duravit	Speciale	PozziGinori	Aurora	Tenax-Simi	Vega
Eos-Simca	Cimino	PozziGinori	Cervinia	Vincenti	Milano
Eos-Simca	Jolly	PozziGinori	Curva	Vitruvit-Profilo	Calipso
Eos-Simca	Orchidea	PozziGinori	Elios	Vitruvit-Profilo	Lady
Eos-Simca	Tulipano	PozziGinori	Europa	Vitruvit-Profilo	Minerva
Etruria	Sirio	PozziGinori	Fantasia	Vitruvit-Profilo	Partenone
Euroceramiche	Iris	PozziGinori	Gardena	Vitruvit-Profilo	Partenone MB
Falerii	Gaia	PozziGinori	Ginepro	Vitruvit-Profilo	Sky3
Falerii	Novella	PozziGinori	Idro	Vitruvit-Profilo	Sprint

Sedile wc in termoindurente  
Duroplast toilet seat

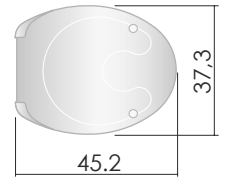
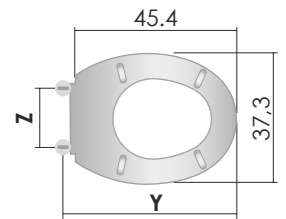

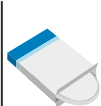
## ANATOMICO



				
Kg. 2,170	Kg. 2,390	m <sup>3</sup> 0,0109	5 pcs Kg. 12,830	5 pcs m <sup>3</sup> 0,070



H011

Cod. 2FSE198002

Y = da 43,5 a 45,5  
Z = da 12,8 a 18,4

Nylon  
Nylon





Sedile wc in termoindurente  
Duroplast toilet seat

AP

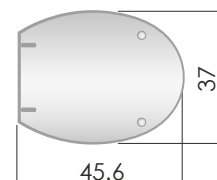
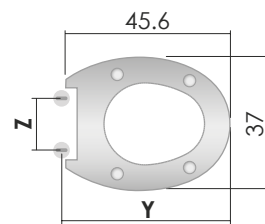

Kg. 2,050	Kg. 2,200	m³ 0,0120	5 pcs	5 pcs
			Kg. 11,800	m³ 0,070





	<b>H011</b>	<b>Cod. 2FSE209502</b>	Y = da 43,2 a 45,2 Z = da 14 a 19	Nylon Nylon	
	<b>H057</b>	<b>Cod. 2FSE209702</b>	Y = da 42,5 a 46,5 Z = da 14 a 18	Inox Stainless steel	
	<b>H050</b>	<b>Cod. 2FSE209602</b>	Y = da 42 a 47 Z = da 11 a 21	Inox Stainless steel	  
	<b>H481</b>	<b>Cod. 2FSE209902</b>	Y = da 41,5 a 47,5 Z = da 9,5 a 21,5	Nylon metallo Nylon metal	   
	<b>H481</b>	<b>Cod. 2FSE209902AB</b> Materiale antibatterico Antibacterial material	Y = da 41,5 a 47,5 Z = da 9,5 a 21,5	Nylon metallo Nylon metal	    
	<b>H482</b>	<b>Cod. 2FSE210602</b>	Y = da 41,5 a 47,5 Z = da 9,5 a 21,5	Nylon metallo Nylon metal	   

Sedile wc in termoindurente  
Duroplast toilet seat

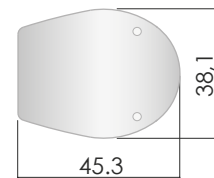
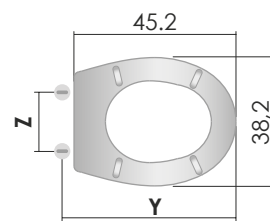

**BERNINA**



				
Kg. 1,730	Kg. 1,945	m <sup>3</sup> 0,0109	5 pcs	5 pcs
			Kg. 10,615	m <sup>3</sup> 0,070



H011

Cod. 2FSE177002

Y = da 43,3 a 45,2  
Z = da 12,8 a 18,2

Nylon  
Nylon







Sedile wc in termoindurente  
Duroplast toilet seat

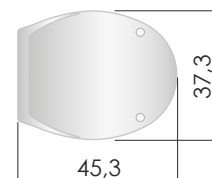
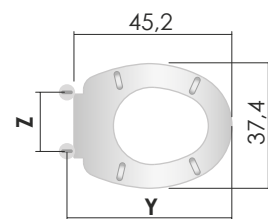

## FELICE



				
Kg. 1,685	Kg. 1,900	m <sup>3</sup> 0,0109	5 pcs Kg. 10,430	5 pcs m <sup>3</sup> 0,070



H011

Cod. 2FSE168002

Y = da 42,7 a 44,9  
Z = da 12,6 a 17,5

Nylon  
Nylon







Sedile wc in termoindurente  
Duroplast toilet seat

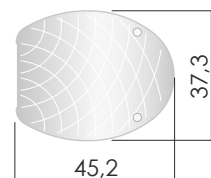
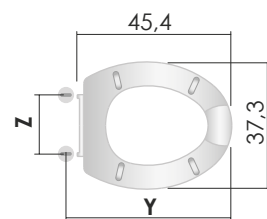

## GIGLIO



				
Kg. 2,245	Kg. 2,465	m <sup>3</sup> 0,0109	5 pcs Kg. 13,070	5 pcs m <sup>3</sup> 0,070



H011

Cod. 2FSE005002

Y = da 43,5 a 45,5  
Z = da 12,6 a 17,4

Nylon  
Nylon









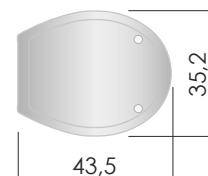
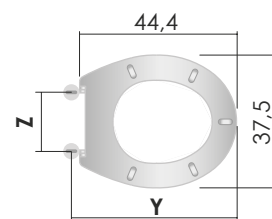



Sedile wc in termoindurente  
Duroplast toilet seat



ISEO



				
Kg. 1,470	Kg. 1,690	m <sup>3</sup> 0,0109	5 pcs	5 pcs
			Kg. 9,450	m <sup>3</sup> 0,070





	<b>H010</b>	<b>Cod. 2FSE176602</b>	Y = da 42,1 a 44,5 Z = da 12,8 a 17,5	Nylon Nylon	
	<b>H016</b>	<b>Cod. 2FSE176702</b>	Y = da 42,1 a 45,5 Z = da 10,8 a 17,5	Nylon Nylon	 

Sedile wc in termoindurente  
Duroplast toilet seat

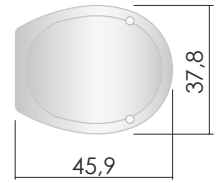
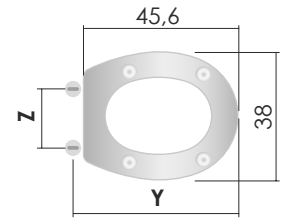

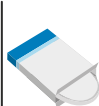
## LIMONE



				
Kg. 2,650	Kg. 2,800	m <sup>3</sup> 0,0109	5 pcs	5 pcs
			Kg. 15,200	m <sup>3</sup> 0,070



LIMONE

Cod. 2FSE167002

Y = da 42,8 a 46,8  
Z = da 11,7 a 17,4

Inox  
Stainless  
steel







Sedile wc in termoindurente  
Duroplast toilet seat

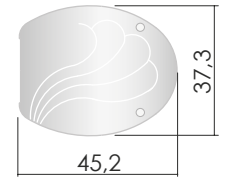
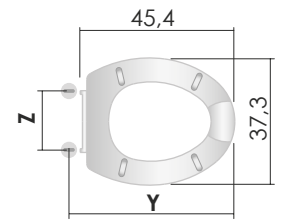

**LOTO**



				
Kg. 2,245	Kg. 2,465	m <sup>3</sup> 0,0109	5 pcs Kg. 13,070	5 pcs m <sup>3</sup> 0,070



H011

Cod. 2FSE002002

Y = da 43,5 a 45,5  
Z = da 12,6 a 17,4

Nylon  
Nylon



# MAMBO

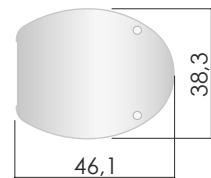
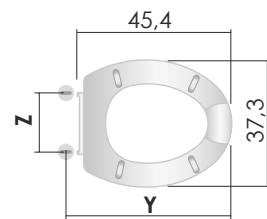

Kg. 2,210	Kg. 2,430	m <sup>3</sup> 0,0109	3 pcs Slow close	5 pcs	3 pcs 5 pcs
			Kg. 8,000	Kg. 13,100	m <sup>3</sup> 0,038 m <sup>3</sup> 0,070

	<b>H011</b>	<b>Cod. 2FSE007802</b>	Y = da 44,1 a 46 Z = da 12,2 a 17,1	Nylon Nylon	
	<b>H057</b>	<b>Cod. 2FSE167702</b>	Y = da 43,3 a 47,4 Z = da 13,1 a 17,5	Inox Stainless steel	
	<b>H050</b>	<b>Cod. 2FSE009202</b>	Y = da 42,2 a 47,7 Z = da 9,5 a 19,5	Inox Stainless steel	  
	<b>H323</b>	<b>Cod. 2FSE017502</b>	Y = da 41,7 a 47 Z = da 9 a 19	Metallo cromato Metal chrome	  







Sedile wc in termoindurente  
Duroplast toilet seat

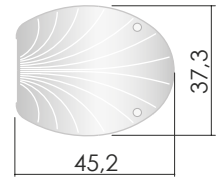
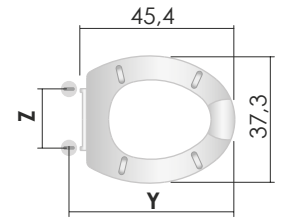

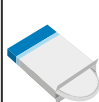
**MARE**



				
Kg. 2,040	Kg. 2,260	m <sup>3</sup> 0,0109	5 pcs	5 pcs
			Kg. 12,205	m <sup>3</sup> 0,070



H011

**Cod. 2FSE160002**

Y = da 43,5 a 45,5  
Z = da 12,6 a 17,4





Nylon  
Nylon



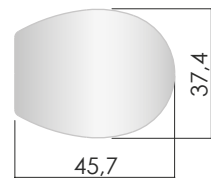
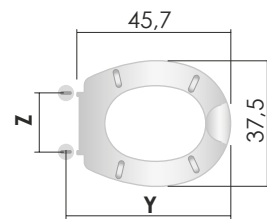





Sedile wc in termoindurente  
Duroplast toilet seat

MITHO



				
Kg. 1,970	Kg. 2,190	m <sup>3</sup> 0,0109	5 pcs	5 pcs
			Kg. 12,000	m <sup>3</sup> 0,070





	<b>H011</b>	<b>Cod. 2FSE002202</b>	Y = da 43,6 a 45,3 Z = da 12,8 a 18,4	Nylon Nylon	
	<b>H019</b>	<b>Cod. 2FSE004902</b>	Y = da 43,5 a 46,4 Z = da 11,8 a 17,8	Nylon Nylon	 
	<b>H057</b>	<b>Cod. 2FSE002402</b>	Y = da 43,3 a 47 Z = da 13,4 a 17,9	Inox Stainless steel	

Sedile wc in termoindurente  
Duroplast toilet seat

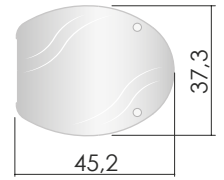
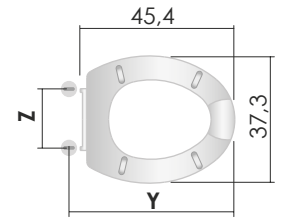

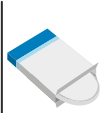
ONDA



				
Kg. 2,040	Kg. 2,260	m <sup>3</sup> 0,0109	5 pcs	5 pcs
			Kg. 12,180	m <sup>3</sup> 0,070



H011

Cod. 2FSE003002

Y = da 43,5 a 45,5  
Z = da 12,6 a 17,4

Nylon  
Nylon







Sedile wc in termoindurente  
Duroplast toilet seat

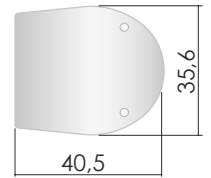
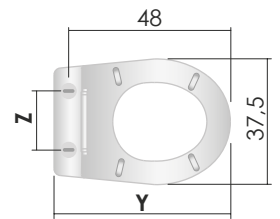

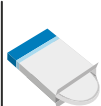
## PANCHETTA



				
Kg. 3,160	Kg. 3,250	m <sup>3</sup> 0,0106	5 pcs	5 pcs
			Kg. 17,060	m <sup>3</sup> 0,066



H013

Cod. 2FSE197002

Y = da 42 a 45,6  
Z = da 13,7 a 16,9

Nylon  
Nylon



Sedile wc in termoindurente  
Duroplast toilet seat



REVERSE

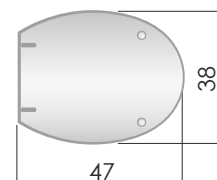
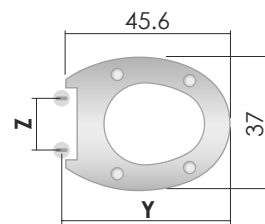

Kg. 2,050	Kg. 2,250	m <sup>3</sup> 0,0109	5 pcs Kg. 13,400	5 pcs m <sup>3</sup> 0,070

	<b>H057</b>	<b>Cod. 2FSE033202</b>	Y = da 42,5 a 46,5 Z = da 14 a 18	Inox Stainless steel	
	<b>H050</b>	<b>Cod. 2FSE029702</b>	Y = da 42 a 47 Z = da 11 a 21	Inox Stainless steel	
	<b>H481</b>	<b>Cod. 2FSE029502</b>	Y = da 41,5 a 47,5 Z = da 9,5 a 21,5	Nylon metallo Nylon metal	
	<b>H482</b>	<b>Cod. 2FSE021702</b>	Y = da 41,5 a 47,5 Z = da 9,5 a 21,5	Nylon metallo Nylon metal	

Sedile wc in termoplastico  
Duroplast toilet seat

## REVERSE - DOWNLOADING

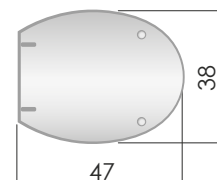
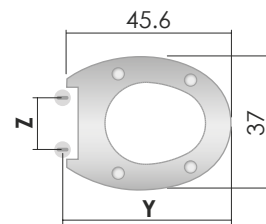

Kg. 2,050	Kg. 2,250	m <sup>3</sup> 0,0109	5 pcs	5 pcs
			Kg. 13,400	m <sup>3</sup> 0,070







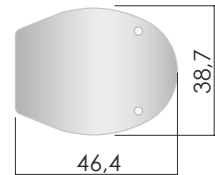
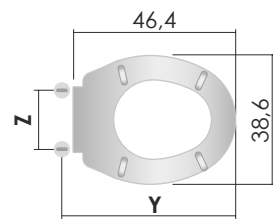

	<b>H050</b>	<b>Cod. 2FSE034600</b>	Y = da 42 a 47 Z = da 11 a 21	Inox Stainless steel	
	<b>H481</b>	<b>Cod. 2FSE033600</b>	Y = da 41,5 a 47,5 Z = da 9,5 a 21,5	Nylon metallo Nylon metal	
	<b>H482</b>	<b>Cod. 2FSE000000</b>	Y = da 41,5 a 47,5 Z = da 9,5 a 21,5	Nylon metallo Nylon metal	

Sedile wc in termoindurente  
Duroplast toilet seat

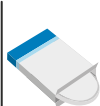

RIVA



				
Kg. 1,810	Kg. 2,035	m <sup>3</sup> 0,0109	5 pcs	5 pcs
			Kg. 10,950	m <sup>3</sup> 0,070



H012

Cod. 2FSE166002

Y = da 43,1 a 47,3  
Z = da 12,7 a 17,7

Nylon  
Nylon



Sedile wc in termoindurente  
Duroplast toilet seat

SHAPE

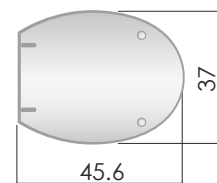
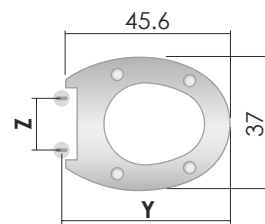

Kg. 2,150	Kg. 2,600	m <sup>3</sup> 0,0120	5 pcs	5 pcs
			Kg. 13,650	m <sup>3</sup> 0,070

	<b>H050</b>	<b>Cod. 2FSE029802</b>	Y = da 42 a 47 Z = da 11 a 21	Inox Stainless steel				
	<b>H057</b>	<b>Cod. 2FSE033302</b>	Y = da 42,5 a 46,5 Z = da 14 a 18	Inox Stainless steel				
	<b>H481</b>	<b>Cod. 2FSE029602</b>	Y = da 41,5 a 47,5 Z = da 9,5 a 21,5	Nylon metallo Nylon metal				
	<b>H482</b>	<b>Cod. 2FSE033700</b>	Y = da 41,5 a 47,5 Z = da 9,5 a 21,5	Nylon metallo Nylon metal				







Sedile wc in termoindurente  
Duroplast toilet seat

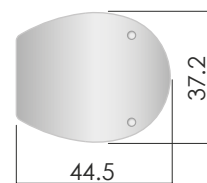
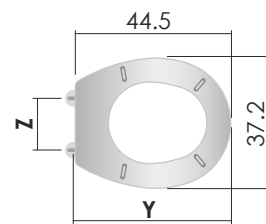

**SOLUTION**



				
Kg. 2,300	Kg. 2,600	m³ 0,0105	5 pcs	5 pcs
			Kg. 13,500	m³ 0,085



**Cod. 2FSE192702**





Y = da 40,7 a 45,7  
Z = da 9 a 19

Inox - abs  
Stainless  
steel - abs

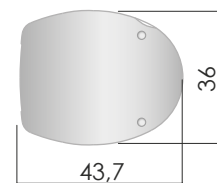
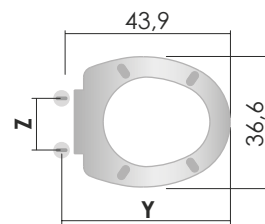

## UNO N

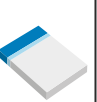

				
Kg. 1,730	Kg. 1,945	m <sup>3</sup> 0,0109	5 pcs	5 pcs
			Kg. 10,615	m <sup>3</sup> 0,070



H057

Cod. 2FSE037502

Y = da 41 a 45,5  
Z = da 12,0 a 18,0

Inox  
Stainless  
steel



H481

Cod. 2FSE163002

Y = da 40,5 a 46  
Z = da 7 a 14,5

Nylon  
metallo  
Nylon  
metal



H482

Cod. 2FSE000000

Y = da 40,5 a 46  
Z = da 7 a 14,5

Nylon  
metallo  
Nylon  
metal





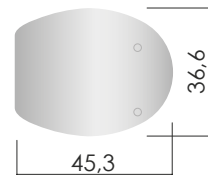
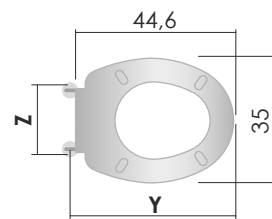



VERSO

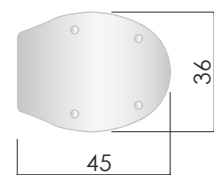
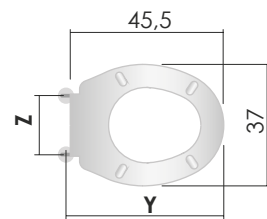









Kg. 2,330	Kg. 2,550	m <sup>3</sup> 0,0109	3 pcs Slow close	5 pcs	3 pcs 5 pcs
			Kg. 8,200	Kg. 13,575	m <sup>3</sup> 0,038 m <sup>3</sup> 0,070

	<b>H011</b>	<b>Cod. 2FSE161202</b>	Y = da 43,0 a 45,0 Z = da 12,3 a 17,9	Nylon Nylon	
	<b>H057</b>	<b>Cod. 2FSE166302</b>	Y = da 42,3 a 46,0 Z = da 13,3 a 17,8	Inox Stainless steel	
	<b>H050</b>	<b>Cod. 2FSE162602</b>	Y = da 41,6 a 47,0 Z = da 9,5 a 19,3	Inox Stainless steel	
	<b>H025</b>	<b>Cod. 2FSE168202</b>	Y = da 43,7 a 44,8 Z = da 15 a 16	Inox Stainless steel	
	<b>H306</b>	<b>Cod. 2FSE174302</b>	Y = da 43,0 a 44,9 Z = da 17,3 a 17,9	Nylon Nylon	
	<b>H323</b>	<b>Cod. 2FSE175302</b>	Y = da 42,1 a 47,8 Z = da 8,6 a 18,7	Metallo cromato Metal chrome	



					
Kg. 1.360	Kg. 1.550	m <sup>3</sup> 0.0109	5 pcs Slow close	5 pcs	5 pcs
			Kg. 7.750	Kg. 7.750	m <sup>3</sup> 0.070

	<b>H011</b>	<b>Cod. 2FSE014702</b>	Y = da 43,5 a 45,6 Z = da 11,7 a 17,4	Nylon Nylon	
	<b>H025</b>	<b>Cod. 2FSE015002</b>	Y = da 43,4 a 44,7 Z = da 14 a 15	Inox Stainless steel	
	<b>H057</b>	<b>Cod. 2FSE192502</b>	Y = da 42,7 a 46,3 Z = da 11,9 a 17,6	Inox Stainless steel	
	<b>H306</b>	<b>Cod. 2FSE014802</b>	Y = da 43,5 a 45,6 Z = da 11,7 a 17,4	Nylon Nylon	 

Sedile wc in termoindurente  
Duroplast toilet seat



H011

Cod. 2FSE196002

Y = da 43,5 a 45,6  
Z = da 11,7 a 17,4

Nylon  
Nylon



Z1

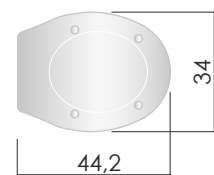
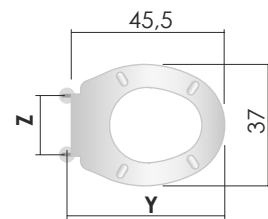

Kg. 1,350	Kg. 1,560	m <sup>3</sup> 0,0109	5 pcs	5 pcs
			Kg. 8,620	m <sup>3</sup> 0,070



H012

Cod. 2FSE173002

Y = da 43,1 a 47,5  
Z = da 12 a 17

Nylon  
Nylon



Z2

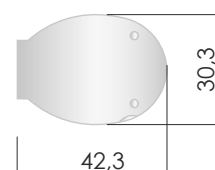
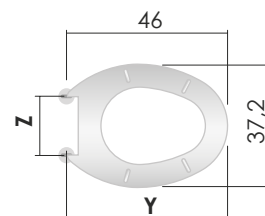

Kg. 1,400	Kg. 1,450	m <sup>3</sup> 0,0109	5 pcs	5 pcs
			Kg. 7,900	m <sup>3</sup> 0,040

Sedile wc in termoindurente  
Duroplast toilet seat



## Z10

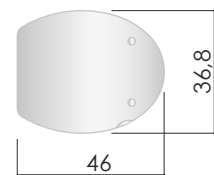
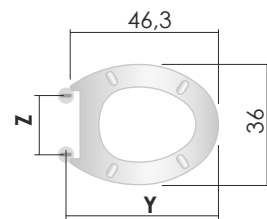

Kg. 2,810	Kg. 2,900	m <sup>3</sup> 0,0106	5 pcs	5 pcs
		Kg. 15,380	m <sup>3</sup> 0,066	



H012

Cod. 2FSE169002

Y = da 42,6 a 47,7  
Z = da 12 a 17

Nylon  
Nylon



## Z10 S

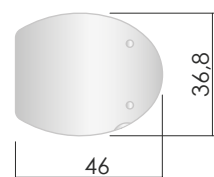
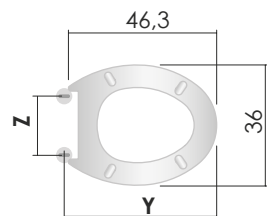

Kg. 1,830	Kg. 2,050	m <sup>3</sup> 0,0106	5 pcs	5 pcs
		Kg. 11,095	m <sup>3</sup> 0,066	



H012

Cod. 2FSE171002

Y = da 42,6 a 47,7  
Z = da 12 a 17

Nylon  
Nylon



A white toilet seat is shown from a top-down perspective. On the left side, there is a large, stylized blue graphic consisting of interconnected geometric shapes, resembling a modern logo or architectural element. The text is positioned on the right side of the seat, oriented vertically.

**SEDILI WC IN TERMOINDURENTE A FORMA UNIVERSALE DECORATI  
DECORATED UNIVERSAL SHAPED DUROPLAST WC SEATS**

Sedile wc in termoindurente  
Duroplast toilet seat



H057

Cod. 2FSE023400

Y = da 42,7 a 46,3  
Z = da 11,9 a 17,6

Inox  
Stainless  
steel



## ALLUMINIO

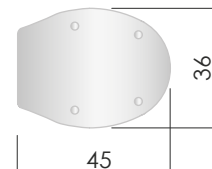
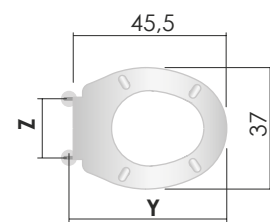

Kg. 1,360	Kg. 1,550	m <sup>3</sup> 0,0109	5 pcs Kg. 7,750	5 pcs m <sup>3</sup> 0,038 m <sup>3</sup> 0,070

## AUTUMN



H057

Cod. 2FSE025800

Y = da 42,7 a 46,3  
Z = da 11,9 a 17,6

Inox  
Stainless  
steel

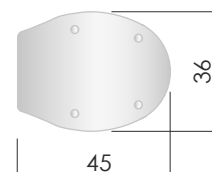
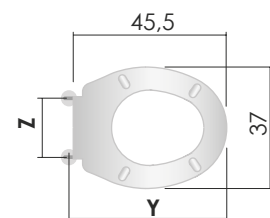

Kg. 1,360	Kg. 1,550	m <sup>3</sup> 0,0109	5 pcs Kg. 7,750	5 pcs m <sup>3</sup> 0,070



Sedile wc in termoindurente  
Duroplast toilet seat



H057

Cod. 2FSE025900

Y = da 42,7 a 46,3  
Z = da 11,9 a 17,6

Inox  
Stainless  
steel



CARACAS

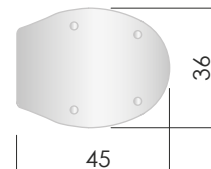
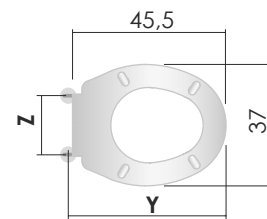

Kg. 1,360	Kg. 1,550	m <sup>3</sup> 0,0109	5 pcs Kg. 7,750	5 pcs m <sup>3</sup> 0,038 m <sup>2</sup> 0,070

COPENAGHEN



H057

Cod. 2FSE026000

Y = da 42,7 a 46,3  
Z = da 11,9 a 17,6

Inox  
Stainless  
steel

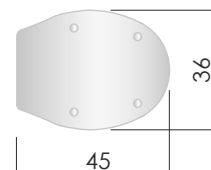
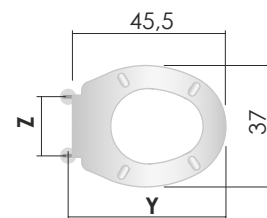

Kg. 1,360	Kg. 1,550	m <sup>3</sup> 0,0109	5 pcs Kg. 7,750	5 pcs m <sup>3</sup> 0,070

Sedile wc in termoindurente  
Duroplast toilet seat



H011

Cod. 2FSE022000

Y = da 43,5 a 45,6  
Z = da 11,7 a 17,4

Nylon  
Nylon



GUFI

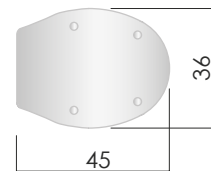
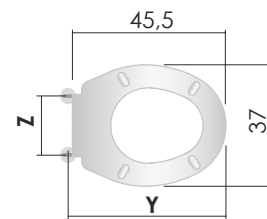

Kg. 1,360	Kg. 1,550	m³ 0,0109	5 pcs	5 pcs
			Kg. 7,750	m³ 0,070



H057

Cod. 2FSE030700

Y = da 42,7 a 46,3  
Z = da 11,9 a 17,6

Inox  
Stainless  
steel



HIPPY

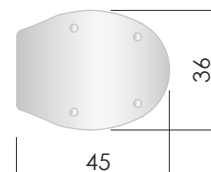
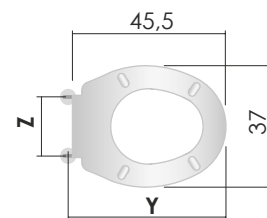

Kg. 1,360	Kg. 1,550	m³ 0,0109	5 pcs	5 pcs
			Kg. 7,750	m³ 0,070

Sedile wc in termoindurente  
Duroplast toilet seat



H057

Cod. 2FSE025500

Y = da 42,7 a 46,3  
Z = da 11,9 a 17,6

Inox  
Stainless  
steel



JEANS

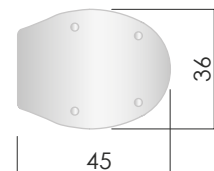
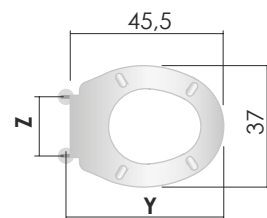

Kg. 1,360	Kg. 1,550	m <sup>3</sup> 0,0109	5 pcs	5 pcs
			Kg. 7,750	m <sup>3</sup> 0,070

LISBONA



H057

Cod. 2FSE024800

Y = da 42,7 a 46,3  
Z = da 11,9 a 17,6

Inox  
Stainless  
steel

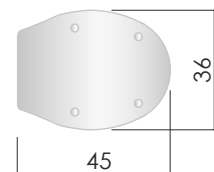
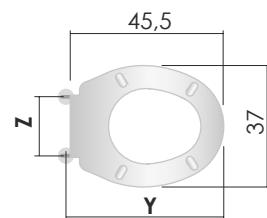

Kg. 1,360	Kg. 1,550	m <sup>3</sup> 0,0109	5 pcs	5 pcs
			Kg. 7,750	m <sup>3</sup> 0,070

Sedile wc in termoindurente  
Duroplast toilet seat



H057

Cod. 2FSE025000

Y = da 42,7 a 46,3  
Z = da 11,9 a 17,6

Inox  
Stainless  
steel



PAINT

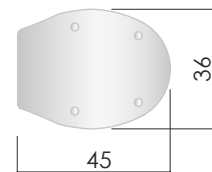
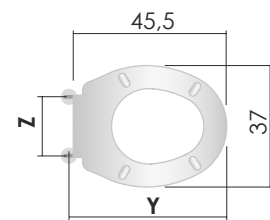

Kg. 1,360	Kg. 1,550	m <sup>2</sup> 0,0109	5 pcs	5 pcs
			Kg. 7,750	m <sup>2</sup> 0,070

SIVIGLIA



H057

Cod. 2FSE025700

Y = da 42,7 a 46,3  
Z = da 11,9 a 17,6

Inox  
Stainless  
steel

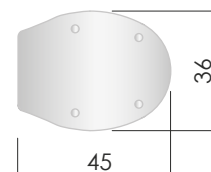
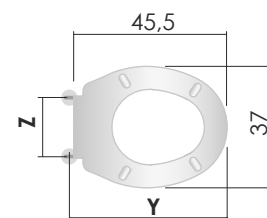

Kg. 1,360	Kg. 1,550	m <sup>2</sup> 0,0109	5 pcs	5 pcs
			Kg. 7,750	m <sup>2</sup> 0,070

Sedile wc in termoindurente  
Duroplast toilet seat



STONE

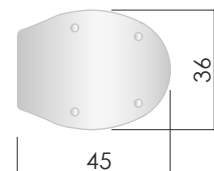
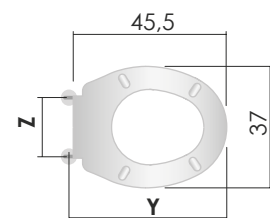

Kg. 1,360	Kg. 1,550	m <sup>3</sup> 0,0109	5 pcs	5 pcs
			Kg. 7,750	m <sup>3</sup> 0,070



H057

Cod. 2FSE153900

Y = da 42,7 a 46,3  
Z = da 11,9 a 17,6

Inox  
Stainless  
steel



SUN

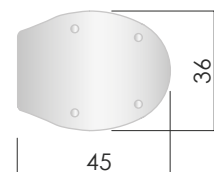
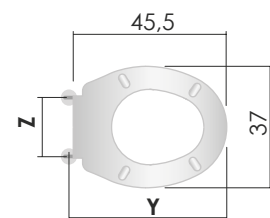

Kg. 1,360	Kg. 1,550	m <sup>3</sup> 0,0109	5 pcs	5 pcs
			Kg. 7,750	m <sup>3</sup> 0,070



H057

Cod. 2FSE025400

Y = da 42,7 a 46,3  
Z = da 11,9 a 17,6

Inox  
Stainless  
steel



Sedile wc in termoindurente  
Duroplast toilet seat



H057

Cod. 2FSE025200

Y = da 42,7 a 46,3  
Z = da 11,9 a 17,6

Inox  
Stainless  
steel



TROPIC

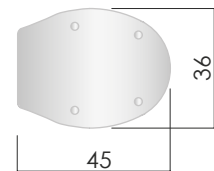
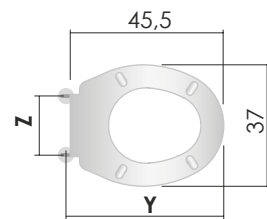

Kg. 1,360	Kg. 1,550	m <sup>3</sup> 0,0109	5 pcs	5 pcs
			Kg. 7,750	m <sup>3</sup> 0,070



H057

Cod. 2FSE025100

Y = da 42,7 a 46,3  
Z = da 11,9 a 17,6

Inox  
Stainless  
steel



WALL

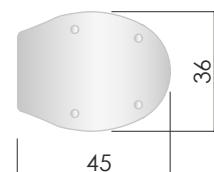
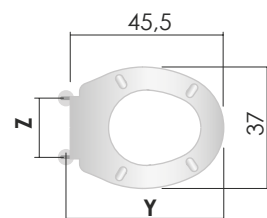

Kg. 1,360	Kg. 1,550	m <sup>3</sup> 0,0109	5 pcs	5 pcs
			Kg. 7,750	m <sup>3</sup> 0,070

Sedile wc in termoindurente  
Duroplast toilet seat



H057

Cod. 2FSE024900





Y = da 42,7 a 46,3  
Z = da 11,9 a 17,6

Inox  
Stainless  
steel

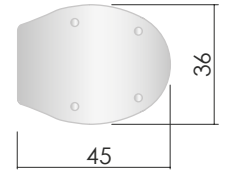
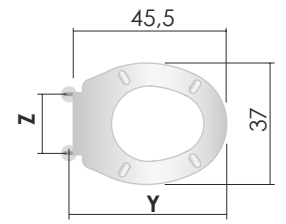

WOOD



				
Kg. 1,360	Kg. 1,550	m³ 0,0109	5 pcs	5 pcs
			Kg. 7,750	m³ 0,070

**SEDILI WC IN TERMOPLASTICO A FORMA UNIVERSALE**  
**UNIVERSAL SHAPED THERMOPLASTIC WC SEATS**





Sedile wc in termoplastico  
Thermoplastic toilet seat



H014

Cod. 2FSE175002

Y = da 42,1 a 43,1  
Z = da 15,5

Nylon  
Nylon



## NEW EVEREST

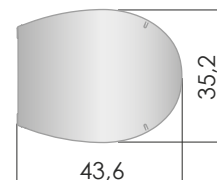
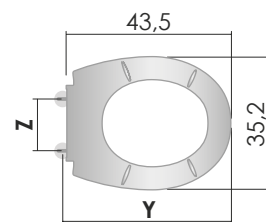

Kg. 0,720	Kg. 0,720	m <sup>3</sup> 0,0060	10 pcs	10 pcs
			Kg. 8,000	m <sup>3</sup> 0,070



H014

Cod. 2FSE175002AB

Y = da 42,1 a 43,1  
Z = da 15,5

Nylon  
Nylon



## NEW EVEREST ANTIBATTERICO

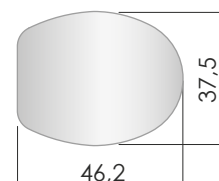
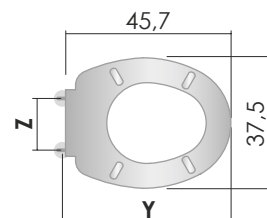





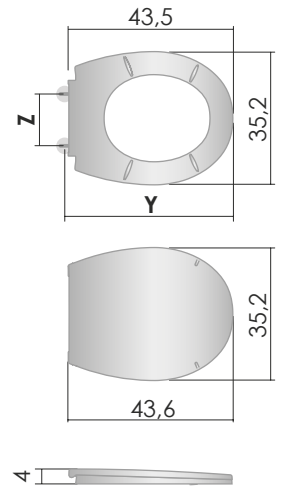

Kg. 0,720	Kg. 0,720	m <sup>3</sup> 0,0060	10 pcs	10 pcs
			Kg. 8,000	m <sup>3</sup> 0,070

Sedile wc in termoplastico  
Thermoplastic toilet seat



## NEW EVEREST NERO



				
Kg. 0,720	Kg. 0,720	m <sup>3</sup> 0,0060	10 pcs Kg. 8,000	10 pcs m <sup>3</sup> 0,070



H014

Cod. 2FSE175001

Y = da 42,1 a 43,1  
Z = da 15,5

Nylon  
Nylon



Sedile wc in termoplastico  
Thermoplastic toilet seat



## ANTIBATTERICO

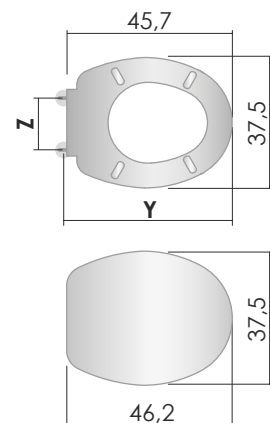

Kg. 1,020	Kg. 1,120	m <sup>3</sup> 0,0090	5 pcs	5 pcs
			Kg. 6,035	m <sup>3</sup> 0,056



H011

Cod. 2FSE028402

Y = da 43,6 a 45  
Z = da 12 a 18

Nylon  
Nylon



## SESTRIERE

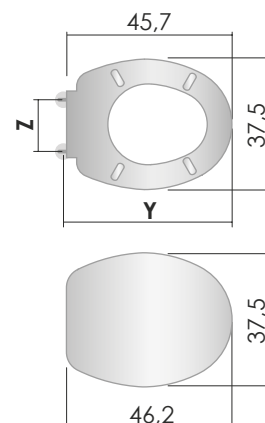

Kg. 1,020	Kg. 1,120	m <sup>3</sup> 0,0090	5 pcs	5 pcs
			Kg. 6,035	m <sup>3</sup> 0,056



H011

Cod. 2FSE005102

Y = da 43,6 a 45  
Z = da 12 a 18

Nylon  
Nylon



Sedile wc in termoplastico  
Thermoplastic toilet seat



## CHAMONIX

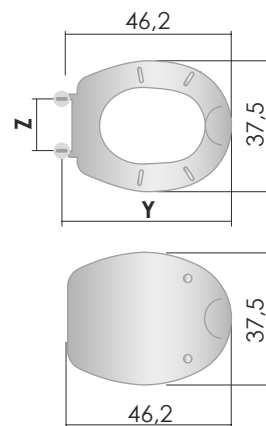

Kg. 1,730	Kg. 1,830	m <sup>3</sup> 0,0100	5 pcs	5 pcs
			Kg. 9,900	m <sup>3</sup> 0,055



H011

Cod. 2FSE005302

Y = da 43,6 a 45,3  
Z = da 12,8 a 18,4

Nylon  
Nylon



Q+

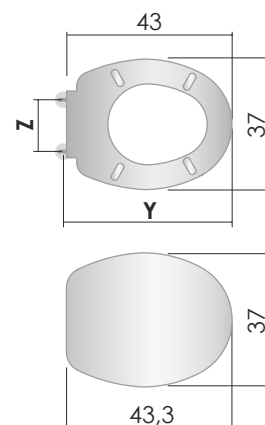

Kg. 1,450	Kg. 1,600	m <sup>3</sup> 0,0105	5 pcs	5 pcs
			Kg. 8,000	m <sup>3</sup> 0,060



Cod. 2FSE204002







Y = da 40,5 a 46  
Z = da 11,5 a 23

Inox - abs  
Stainless steel - abs





**ADATTABILITÀ PRINCIPALI DEI SEDILI WC IN TERMOINDURENTE  
MAIN ADAPTABILITY OF DUROPLAST WC SEATS**

Codice articolo Item cod.	Descrizione Description	Casa Ceramica Ceramic manuf.	Modello vaso Ceramic mod.	Casa Ceramica Ceramic manuf.	Modello vaso Ceramic mod.
2FSE209902	AP H481 	Althea (Sanitalia)	Cento Hola	Hatria-Spea Ideal Standard	Amalfi Ponti
		Archiade	Fausta Flaminia Fulvia	Ilca	Micene Tebe
		Artigianato Ceramico	Duna Ghibli Osai	Incea Olympia Pozzi Ginori	Supra Ambra Arcobaleno Aura Aurora Cervinia Curva Elios Europa Fantasia Gardena Ginepro Idro Modulo Selnova Selva Tabor Torcello
		Astra	Impero MB Olimpia		
		Axa	Mirto		
		Azzurra	Giove		
		Catalano	Luce		
		Ceramica Cielo	Ermes		
		Cesabo	Alexandra Alessandro Elite		
		Cesame	Simplex		
2FSE029502	REVERSE H481 	Cierre Sanitari	Ortisei		
		Delta	Oceano New Raffaello		
2FSE033302	SHAPE H057				
2FSE029602	H481 				
2FSE192702	SOLUTION 	Duravit	Architec Darling Laconda Speciale	Rak Roca Sbordoni Scala	Karla Neo Victoria Flaminia
		Eos-Simca	Cimino Jolly Orchidea Tulipano		Friuli Longa Primavera Rugiada Tau
2FSE161202	VERSO H011			Senesi	Brunello Leonardo Michelangelo
2FSE174302	H306 	Etruria	Sirio		
2FSE014702	Z0 H011	Euroceramiche	Iris		
		Falerii	Gaia Novella Sabrina	Simas	Alfa Beta Deborah Eco Gatteo Montezuma
2FSE014802	H306 	Flaminia	Arena Pompei		
		G.S.G.	Alfa Atene Roma	Sole	Egeo
2FSE014802	H306 	G.S.I.	Garda Giada Iseo Lugano Modo Topazio	Tenax-Simi Vincenti Vitruvit-Profilì	Airone Vega Milano Calipso Lady Minerva Partenone Partenone MB Sky3 Sprint
		Galassia	Olà Vera		
		Globo	Arianna		
		Gravena	Derby Jenny		

Codice articolo Item cod.	Descrizione Description	Casa Ceramica Ceramic manuf.	Modello vaso Ceramic mod.	Casa Ceramica Ceramic manuf.	Modello vaso Ceramic mod.
2FSE200002	AQUA H323 	Althea (Sanitalia)	Cora Plaza Rose	Flaminia	Isabel Metro Spin
		Astra	Gemma Hi-fi Mia Serie 83	G.S.G.	Ambra
				Globo	Flavia (Alia) Grace Open Space
		Axa	Axa2	Gravena	Pendy
		Azzurra	Afrodite Diana Elena Elios Giulia MB Le Onde Midas Novecento Ottocento	Hidra	Onda Pegaso
				Jumbo	Aretha Arethona Tua
				Kerafina	Lito Vergina
				Kerasan	Elka Godia
		Cesame	Aretusa	Roca	Zoom
		Cierre Sanitari	Desirée Okay Piuma Super	Sbordoni	Sospesa
Senesi	Sovana				
Simas	Primavera Selenia				
Duravit	Nube	Sole	Elisa		
Eos - Simca	Armonia Astro Flower Ola	Vavid	Orientale		
		Vincenti	Farah Uno		
Etruria	Alba				
Falerii	Adria Aida Giulietta				

2FSE203102	ARIA H050	Globo	Alia Duo	Hatria	Dolcevit
		Flaminia	App Quick Link	Ideal Standard	Absolute Kurokawa
				Laufen	Object
		Nero Ceramica	Genesi		

2FSE205102	ARIA H057	Catalano	Canova	Kerasan	Montego	
		Cesame	Sintesi Sospesa		Olympia	Federica
		Cierre Sanitari	Dea			Rubino 1
		Delta	Gea			Rubino 2
		Dolomite	RC 80			Serie 92
		Duravit	Dellarco Vienna			Serie 92 sospesa
						Vaso c/esalatore
		Eos-Simca	Antaga			Vela
		Falerii	Chiara			Vela 2
		Flaminia	Link			Vogue
		Globo	Misura 1	Pozzi Ginori	Atena	
		G.S.I.	Avant Dafne Desy Giulia		Linea	
					Roca	Tipo
					Tenax-Simi	Geo
		Vavid	Tebe			
Hatria-Spea	Marilyn	Volleroy & Boch	Alpina			
Incea	Sara		Magnum			

Adattabilità principali dei sedili in termoidurente - Main adaptability of duroplast toilet seats

Codice articolo Item cod.	Descrizione Description	Casa Ceramica Ceramic manuf.	Modello vaso Ceramic mod.	Casa Ceramica Ceramic manuf.	Modello vaso Ceramic mod.
2FSE200302	ARIA H323 	Catalano	Canova	Incea	Sara
		Cesame	Sintesi Sospesa	Kerasan	Montego
		Cierre Sanitari	Dea	Laufen	Object
		Delta	Gea	Nero Ceramica	Genesi
		Dolomite	RC 80	Olympia	Federica
		Duravit	Dellarco Vienna		Rubino 1
		Eos-Simca	Antaga		Rubino 2
		Falerii	Chiara		Serie 92
		Flamina	App Link Quick		Serie 92 sospesa
		Globo	Alia Duo Misura 1	Pozzi Ginori	Vaso c/esalatore
		G.S.I.	Avant Dafne Desy Giulia		Vela
		Hatria	Dolcevita		Vela 2
		Hatria-Spea	Marilyn	Volleroy & Boch	Vogue
Ideal Standard	Absolute Kurokawa	Atena			
2FSE205702	BILBAO H050	Azzurra	Full 56	Hidra	Loft
2FSE033402	BILBAO H481 	Delta	Smart	Valadares	Oceanus MB
		Falerii	Victoria		
		Galassia	Princes		
2FSE197102	CARENA	Cidneo	Pancare Carena		
2FSE192402	DOUBLE	Artigianato Ceramico	Rex	Ideal Standard	Conca
		Cierre Sanitari	Cortina	Isvea	C.O.
		Cesabo	Prestige	Nero Ceramica	Aliseo
		Etruria	Etruria		Aliso sospeso
		Euroceramiche	Gioia	Scic	Maxi lusso
		Falerii	Medina	Senesi	Duccio
		G.S.I.	Vela Traccia	Vincenti	Versilia
		Gravena	Conny	Vitruvit-Profilii	Florida MB
Hidra	Montreal	Gronda			
					Pella
2FSE055002	D-CODE	Duravit	D-Code		
2FSE192202	DYNASTY H050	Catalano	Zero light 50	Scala	Meridiana
		Globo	Diva	Galassia	Eden
		Globo	New Arianna	Ideal Standard	Tonda
2FSE172702	FIVE H025	Cifal	Eden	Laufen	Mimo
2FSE172802	FIVE H306 	G.S.I.	X2	Senesi	Pienza
		Ideal Standard	Tesi	Vincenti	Curva
		Sanex	Tania		
2FSE202002	MATCH H050	Ideal Standard	Connect		
2FSE209202	MATCH H481 				



Codice articolo Item cod.	Descrizione Description	Casa Ceramica Ceramic manuf.	Modello vaso Ceramic mod.	Casa Ceramica Ceramic manuf.	Modello vaso Ceramic mod.
2FSE165802	LUNA H057	Olympia	Federica Rubino 1 Rubino 2 Serie 92 Serie 92 sospesa Vaso c/esalatore Vela Vela 2 Vogue		

2FSE202802	LUNA 2 H057	Althea (Sanitalia)	Althea Marea Marion Melrose Ring	Falerii Flaminia	Tiffany Fidia Fidia vecchio Link Mini Link Relax Relax sospesa Valentine Nuovo
		Amerina	Arco Armony		
		Archiade	Marina		
		Artigianato Ceramico	Croma	Galassia	Aster
		Astra	Divina Serie 84 Serie 85 Clivia Sicilia Verbena	G.S.G. G.S.I.	Astra Jasmine Blitz Elisa Pitti
		Azzurra	Divina Frine I Sensi Paola Venere	Globo Gravena Hatria-Spea Hidra Indusa	Alia Garbo Dolcevita Pluvia Top Line Alfa
		Catalano	Canova Odeon Visa	Jumbo Kerafina	Renoire Simpaty Fryni
		Ceramica Cielo	Ares Celia Florence	Kerasan Olympia	Mantego Narkios Rio
		Cesabo	Endurance	Sanindusa	Alpha Prestige
		Cesame	Sintesi Sintesi sospeso System	Sbordoni Scic	Marina Bella Donna L'altra Linea
		Cierre Sanitari	Dea Okay 2 sospesa		
		Delta	Gea Navona Sahara Solara	Senesi Tenax-Simi Vavid Veliero	Tosca Geo Tebe Odissesa
		Eos-Simca	Antaga	Vincenti	Tipo
		Euroceramiche	Valentina	Vitra Vitruvit-Profil	S50 Fantasia Stella

Adattabilità principali dei sedili in termoidurente - Main adaptability of duroplast toilet seats

Codice articolo Item cod.	Descrizione Description	Casa Ceramica Ceramic manuf.	Modello vaso Ceramic mod.	Casa Ceramica Ceramic manuf.	Modello vaso Ceramic mod.	
2FSE000802	LUNA 2 H323 	Althea (Sanitalia)	Althea Marea Marion Melrose Ring	G.S.I.	Avant Blitz Dafne Desy Elisa Giulia Pitti Community	
		Amerina	Arco Armony		Gravena	Garbo
		Archiade	Sospesa Marina			Hatria-Spea
		Artigianato Ceramico	Croma	Hidra	Ideal Standard	Pluvia Pluvia Sospeso Top Line
		Astra	Divina Serie 84 Serie 85 Clivia Sicilia Verbena			Esedra Fiorile Sospeso Fiorile Lusso Fiorile New Linda Moderno Wash Point
		Azzurra	Nuvola Divina Frine I Sensi Paola Venere			
		Catalano	Canova Odeon Free Visa	Incea	Sara	
				Indusa	Alfa	
				Jumbo	Renoire Simpaty	
		Ceramica Cielo	Smile Ares Celia Florence	Kerafina	Fryni Narkios	
				Kerasan	Montego	
		Cesabo	Endurance	Olympia	Federica Rio Rubino 1 Rubino 2 Serie 92 Serie 92 sospesa Vaso c/esalatore Vela Vela 2 Vogue	
		Cesame	Sintesi Sospesa System			
		Cierre Sanitari	Dea Okay 2 sospesa			
		Delta	Navona Sahara Solara			
		Disegno Ceramica	Skip	Pozzi Ginori	Atena Linea Ydra	
		Dolomite	Alpina			
			Clodia Clodia MB Quadrarco RC 80			Rak
		Duravit	Dellarco Erica Vienna	Roca	Nexo Tipo	
				Sanindusa	Alpha Prestige	

Codice articolo Item cod.	Descrizione Description	Casa Ceramica Ceramic manuf.	Modello vaso Ceramic mod.	Casa Ceramica Ceramic manuf.	Modello vaso Ceramic mod.
2FSE000802	LUNA 2 H323 	Eos-Simca	Antaga Punto Riace-Segesta	Sbordoni Scic	Marina Bella Donna L'altra Linea
		Esedra	Ever		
		Euroceramiche	Valentina	Senesi	Tosca Tuscia
		Falerii	Chiara Tiffany	Tenax-Simi	Geo
		Flaminia	Link Relax Relax sospesa Valentine Nuovo Void	Vavid	Tebe
				Veliero	Odissesa
				Villeroy & Boch	Alpina Magnum
		Globo	Open Space Concept Alia Misura 1	Vincenti	Tipo
				Vitra	S50
		G.S.G.	Astra Jasmine	Vulcano	Fantasia Stella Armonia Classia

2FSE000502	LUNA 2 H050	Archiade	Sospesa	G.S.I.	Community
		Azzurra	Nuvola	Hatria-Spea	Daytime
		Catalano	Free	Ideal Standard	Fiorile Sospeso
		Ceramica Cielo	Smile		Fiorile Lusso
		Disegno Ceramica	Skip		Fiorile New
		Dolomite	Alpina Clodia Clodia MB Quadrarco		Linda Moderno Wash Point
				Duravit	Erica
		Eos-Simca	Punto Riace-Segesta	Rak	Compact
		Esedra	Ever	Roca	Nexo
		Flamina	Void	Senesi	Tuscia
Globo	Open Space Concept	Vitruvit-Profilii	Armonia		
		Vulcano	Classia		

2FSE009202	MAMBO H050	Althea (Sanitalia)	900	Galassia	Krio
			Fly	Hatria-Spea	Erika Pro Onda
		Amerina	Old Italy	Ideal Standard	Ala Ala-sospeso
		Azzurra	Deca Dodeca Elios sospesa		Laufen
			Cesabo	Exel	Olympia
		Cesame	Equa	Pozzi Ginori	Baia Pratika Stile Stilnova
		Cierre Sanitari	Terminillo		
		Delta	Gioia Cadore		
		Dolomite	Corallo Corallo sospesa	Sbordoni	Fulvia
		Esedra	Esedra	Scic	Maxi Aurea
		Flaminia	Web	Simas	Luna
		G.S.I.	Clizia	Vulcano	Yesterday
			Essenza		
			Oceano nuovo Fahrenheit Tecla		

Adattabilità principali dei sedili in termoidurente - Main adaptability of duroplast toilet seats

Codice articolo Item cod.	Descrizione Description	Casa Ceramica Ceramic manuf.	Modello vaso Ceramic mod.	Casa Ceramica Ceramic manuf.	Modello vaso Ceramic mod.
2FSE167702	MAMBO H057	Azzurra Ceramica Cielo	Full 56 Lara	Globo	Lei

2FSE017502	MAMBO H323 	Althea (Sanitalia)	900 Fly	Galassia Globo	Krio Lei
		Amerina	Old Italy	Hatria-Spea	Erika Pro Onda
		Azzurra	Deca Dodeca Elios sospesa	Ideal Standard	Ala Ala-sospeso
		Ceramica Cielo	Lara	Laufen	Swing
		Cesabo	Exel	Olympia	Aurelia Merkur
		Cesame	Equa	Pozzi Ginori	Baia Pratika Stile Stilnova
		Cierre Sanitari	Terminillo		
		Delta	Gioia		
		Dolomite	Cadore Corallo sospesa		
		Esedra	Esedra	Sbordoni	Fulvia
		Flaminia	Web	Scic	Maxi Aurea
		G.S.I.	Clizia Oceano nuovo Fahrenheit Tecla	Simas Vulcano	Luna Yesterday

2FSE002202	MITHO H011	Gravena	Rhonda	Sbordoni	Fabia
		Ideal Standard	Liuto	Scala	Tanga

2FSE002402	MITHO H057	Eos-Simca	Mistral	Sbordoni	Fabia
		Gravena	Rhonda	Scala	Tanga
		Ideal Standard	Liuto		

2FSE166402	PASSEPARTOUT H050	Azzurra	Afrodite Elios Plus Minerva	Hidra Isvea Kerafina	Memory Monika Millenium
		Catalano	Neve Neve New	Pozzi Ginori	Easy Quinta Selnova 3
		Cesame	Belle Epoque		
		Cierre Sanitari	Okay 2	Rak	Metropolitan Washington
		Delta	Futura Golf	Scanitosco	004Open01
		Disegno Ceramica	Giulia	Scic	Kappa
		Dolomite	Garda	Simas	Arcade Europa 2 vers.
		Eos-Simca	Orion Punto Sospesa	Tenax-Simi	Alba Gabbiano
		Flaminia	Sprint sospeso	Vincenti	Antica
		G.S.I.	Davina Fedra	Vitruvit-Profilì	Alessandra Maiorca Young
		Galvid	Mirò	Vulcano	Primavera
		Globo	Grace Filo Parete		
		Gravena	Croma		

Adattabilità principali dei sedili in termoidurente - Main adaptability of duroplast toilet seats

Codice articolo Item cod.	Descrizione Description	Casa Ceramica Ceramic manuf.	Modello vaso Ceramic mod.	Casa Ceramica Ceramic manuf.	Modello vaso Ceramic mod.
2FSE164602	PASSEPARTOUT H057	Althea (Sanitalia)	Elena	G.S.I.	Xenia 1
		Catalano	Acqua Aria Nuovo	Galassia	Piuma
		Cesame	900 Aretusa Sospesa Aretusina Aretusina MB	Galvit	Agorà
				Gravena	Gaia Giada
				Hidra	Angela
		Eos-Simca	Clio	Indusa	Aveiro
		Flaminia	Metro sospesa	Laufen	Dino Sospesa
Ideal Standard	Linda vaso terra	Pozzi Ginori	Selnova 3		
		Rak	Orient		

2FSE175502	PASSEPARTOUT H323 	Althea (Sanitalia)	Elena	Galvit	Agorà			
		Azzurra	Afrodite		Mirò			
		Catalano	Acqua Aria Nuovo Aretusa Sospesa Aretusina Aretusina MB Neve New Neve	Globo	Grace Filo Parete			
					Gravena	Croma Gaia Giada		
				Indusa		Aveiro		
				Laufen		Dino Sospesa		
				Hidra		Memory		
				Cesame	Belle Epoque	Ideal Standard	Fiorile Sospeso Linda Moderno	
		Cierre Sanitari	Okay 2				Isvea	Monika
		Delta	Futura Golf	Kerafina	Millenium			
					Disegno Ceramica	Giulia	Pozzi Ginori	Easy Quinta Selnova 3
		Dolomite	Garda	Rak				Orient Washington
								Eos-Simca
		Scic	KAppa					
			Flaminia	Sprint sospeso Metro sospesa	Senesi	Tuscia		
		G.S.I.				Community Davina Fedra Xenia 1	Simas	
			Galassia	Piuma	Tenax-Simi			Alba Gabbiano
								Vulcano
				Vitruvit-Profilì	Alessandra Maiorca Young			

2FSE032902	QUEEN H050	Catalano	Visa	Hidra	Pluvia sospeso
2FSE033002	QUEEN H481 	Delta	Navona	Jumbo	Renoire
		Flaminia	App	Laufen	Object
		Flaminia	Link	Rak	Resort
		Flaminia	Quick	Villeroy&Boch	Subway

Codice articolo Item cod.	Descrizione Description	Casa Ceramica Ceramic manuf.	Modello vaso Ceramic mod.	Casa Ceramica Ceramic manuf.	Modello vaso Ceramic mod.
2FSE007402	SAMBA H011	Catalano	Taormina	Roca	Polo Victoria
		Dolomite	Cristallo Quarzo	Sbordoni	Flavia Kerafin
		Eos-Simca	Medea		Scala
		Falerii	Thermae	Simas	Lory
		Keramag	Koblenz	Vitra	Architect sospeso
		Laufen	Lyra	Vitruvit-Profilii	Diana
		Pozzi Ginori	Cervino Colibrì Ilgarda Kim Monviso		

2FSE158602	SAMBA H057	Catalano	Taormina	Roca	Polo Victoria
		Dolomite	Cristallo Quarzo	Sbordoni	Flavia Kerafin
		Eos-Simca	Medea		Scala
		Falerii	Thermae	Simas	Lory
		Incea	Nube	Vitra	Architect sospeso
		Keramag	Koblenz	Vitruvit-Profilii	Diana
		Laufen	Lyra		
Pozzi Ginori	Cervino Colibrì Ilgarda Kim Monviso				

2FSE005902	SEBINO H011	Catalano	Taormina	Roca	Polo Victoria
		Dolomite	Cristallo Quarzo	Sbordoni	Flavia Kerafin
		Eos-Simca	Medea		Scala
		Falerii	Thermae	Simas	Lory
		Keramag	Koblenz	Vitra	Architect sospeso
		Laufen	Lyra	Vitruvit-Profilii	Diana
		Pozzi Ginori	Cervino Colibrì Idea Ilgarda Kim Monviso		

2FSE016502	SMALL H050	Axa	Round	Hidra	Smarty
		Falerii	F-concept	Roca	Polo New

2FSE037002	SPEED H507	Pozzi Ginori	Fast Selnova Pro		
------------	------------	--------------	---------------------	--	--

2FSE037102	SPEED H515 	Pozzi Ginori	Fast Selnova Pro		
------------	--	--------------	---------------------	--	--

Codice articolo Item cod.	Descrizione Description	Casa Ceramica Ceramic manuf.	Modello vaso Ceramic mod.	Casa Ceramica Ceramic manuf.	Modello vaso Ceramic mod.		
2FSE009602	TANGO / ELLISSE H011	Althea	Sky	Hidra	Athena Brasilia Nautilus Sospesa Record Roma		
		Artigianato Ceramico	Safari				
		Astra	Impero Lido Trio				
		Azzurra	Aris	Ideal Standard	Ellisse Ellisse Più Zanvas (ponti Zeta)		
		Catalano	Junior Dorica Sila Taormina				
		Cierre Sanitari	Leonessa	Ilca	Itaca Menfi Vesuvio		
		Delta	Caravaggio Delta Michelangelo MB Samba				
		2FSE172102	TANGO / ELLISSE H057	Dolomite	Donatello Perla Classic Tenax	Isvea	Aventino
						Eos-Simca	Primula Stylon
				Etruria	Arista Conchiglia		
						Euroceramiche	Più
				Flaminia	Nori		
Galassia	Ala					Sbordoni	Fausta
				Galvit	Egira		Scala
Globo	Arianna MB Lei MB					Scic	
				Hatria-Spea	Baia Cannes Edilizia Erika Monaco Nizza		Senesi
Tenax-Simi	Tenax						
Vavid	Farnese Partenopea						
Vincenti	Brava						
			Vitra	Elena/Normus			
			Vitruvit-Profilii	Roma			

2FSE001602	TERRA H050	Dolomite	Petra	Incea	Laura
		Eos-Simca	Punto sospesa	Jumbo	Esatonda
2FSE001002	TERRA H323 	Flaminia	Link App Quick	Laufen	Object
				Rak	Resort
		Ideal Standard	Absolute Kurokawa Perle Tonic	Villeroy & Boch	Meridian
					Basic Laura Subway

2FSE205902	VALENCIA H050	Catalano	Visa Sphera Zero 45 Zero 55 Visa	Flaminia	Void Fidia
				G.S.I.	Norma Puma
2FSE209302	VALENCIA H481 	Ceramica Cielo	Smile	Galassia	Aster
		Dolomite	Cristallo Nuovo	Globo	Open spacee
		Esedra	Ever	GSI	City Pro
				Ideal Standard	Esedra
				Simas	E-Line

Adattabilità principali dei sedili in termoidurente - Main adaptability of duroplast toilet seats

Codice articolo Item cod.	Descrizione Description	Casa Ceramica Ceramic manuf.	Modello vaso Ceramic mod.	Casa Ceramica Ceramic manuf.	Modello vaso Ceramic mod.
2FSE162602	VERSO H050	Azzurra	Classic	Pozzi Ginori	Ipsilon Ipsinova Sirena
		Cesame	Trieste		
		G.S.I.	Brenta		
2FSE192702	SOLUTION 	Globo	Prima	Rak	Venice
		Hidra	Loft	Scic	Maxi Stile
2FSE209902	AP H481 	Hatria	Nido	Vulcano	Iceberg
		Incea	Iside		
		Nero Ceramica	Iceberg		

2FSE166302	VERSO H057	Delta	Smart	Incea	Jo Opi
		Dolomite	Perla New		
		Falerii	Victoria	Tenax -Simi	Pegaso
		Galassia	Princess	Villeroy & Boch	Pegaso
		Hatria-Spea	Cannes Sospeso Erika Sospeso		

2FSE175302	VERSO H323 	Azzurra	Classic	Nero Ceramica	Iceberg
		Cesame	Trieste	Pozzi Ginori	Ipsilon Ipsinova Sirena
		Dolomite	Perla New		
		G.S.I.	Brenta		
		Globo	Prima	Rak	Venice
		Hatria-Spea	Cannes Sospeso Erika Sospeso	Tenax -Simi	Pegaso
				Scic	Maxi Stile
		Hidra	Loft	Simas	LFT Spazio
Incea	Iside Jo Opi	Villeroy & Boch	Pegaso		
		Vulcano	Iceberg		
		Ideal Standard	Tonda		

2FSE037202	SIX GANCIO	Ideal Standard	Tesi Aquablade		
2FSE037302	SIX SSCS 				

Adattabilità principali dei sedili: in termoindurente - Main adaptability of duroplast toilet seats





**SEDILI WC IN LEGNO FSC**  
**WC SEATS MADE IN FSC WOOD**

Sedili wc in legno FSC®  
Toilet seats in FSC® wood



The mark of  
responsible forestry



I sedili Saniplast sono realizzati con un'anima in legno FSC® proveniente da foreste gestite in maniera corretta e responsabile secondo rigorosi standard ambientali, sociali ed economici.

Il Forest Stewardship Council® è un'organizzazione globale senza fini di lucro dedicata alla promozione della gestione responsabile delle foreste del mondo.

FSC® definisce standard basati su principi riconosciuti di gestione responsabile delle foreste che sono supportati da operatori attivi in campo ambientale, sociale ed economico.

Saniplast seats are made with a core in FSC® wood from forests managed correctly and responsibly according to strict environmental, social and economic standards.

The FSC® (Forest Stewardship Council) is a global, not-for-profit organization dedicated to the promotion of responsible forest management worldwide.

FSC® defines standards based on agreed principles for responsible forest stewardship that are supported by environmental, social and economic stakeholders.



**SITO**

**Cod. 2FSE198802F1**

Bianco Europeo  
Std. white

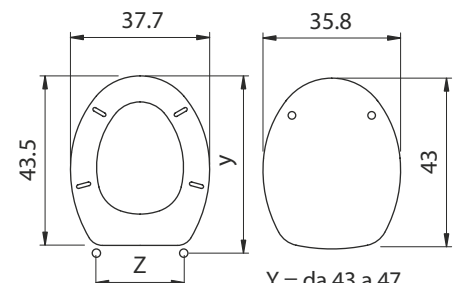

Y = da 43 a 47  
Z = da 10,5 a 20,5

Kg. 4,450	Kg. 4,600	m³ 0,013	3 pcs	3 pcs
			Kg. 13,800	m³ 0,041



Sedili wc in legno FSC®  
Toilet seats in FSC® wood



**START**

**Cod. 2FSE187002F1**

Bianco Europeo  
Std. white

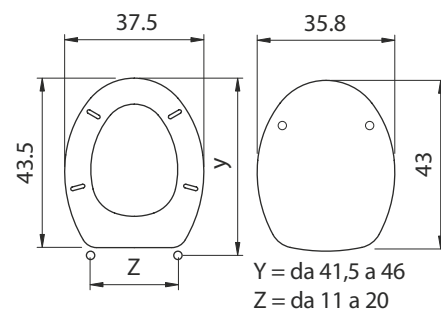

			5 pcs	5 pcs
Kg. 3,600	Kg. 3,740	m³ 0,013	Kg. 18,700	m³ 0,063



**START**

**Cod. 2FSE187001F1**

Nero  
Black

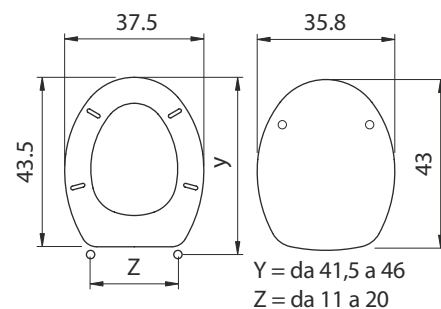

			3 pcs	3 pcs
Kg. 3,600	Kg. 3,740	m³ 0,013	Kg. 11,220	m³ 0,041



**START**

**Cod. 2FSE187029F1**

Blu  
Blue

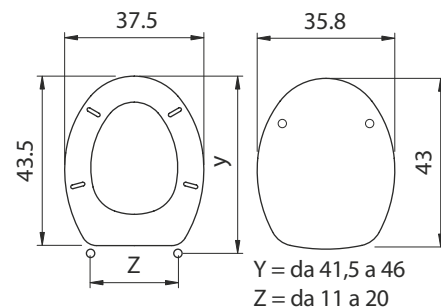

			5 pcs	5 pcs
Kg. 3,600	Kg. 3,740	m³ 0,013	Kg. 11,200	m³ 0,041

Sedili wc in legno FSC®  
Toilet seats in FSC® wood



**START**  
Cod. 2FSE187006F1  
Verde chiaro  
Light green

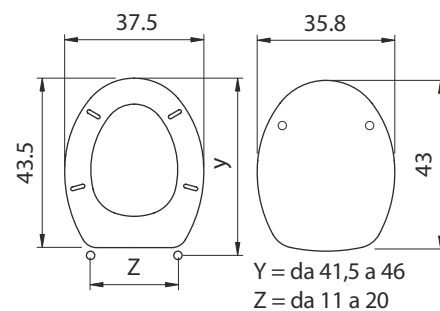

Kg. 3,600	Kg. 3,740	m <sup>3</sup> 0,013	3 pcs	3 pcs
			Kg. 11,200	m <sup>3</sup> 0,041



**START**  
Cod. 2FSE187008F1  
Champagne  
Champagne

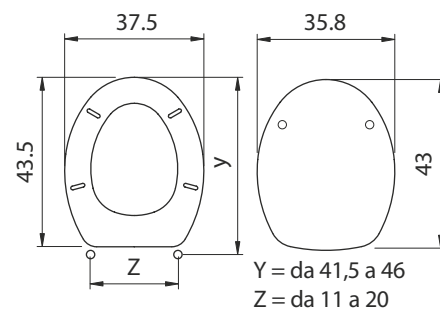

Kg. 3,600	Kg. 3,740	m <sup>3</sup> 0,013	3 pcs	3 pcs
			Kg. 11,200	m <sup>3</sup> 0,041



**START**  
Cod. 2FSE187010F1  
Azzurro  
Light Blue

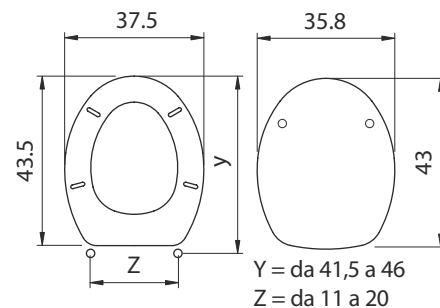

Kg. 3,600	Kg. 3,740	m <sup>3</sup> 0,013	3 pcs	3 pcs
			Kg. 11,200	m <sup>3</sup> 0,041



## Ybò

**Cod. 2FSE182002F1**

Bianco Europeo  
Std. white

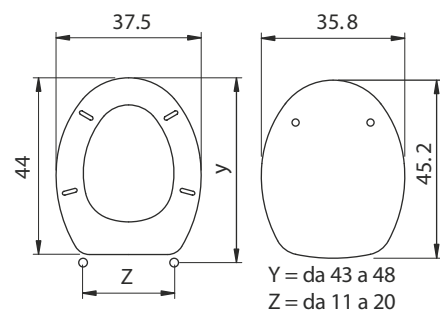

Kg. 3,550	Kg. 3,700	m <sup>3</sup> 0,013	5 pcs	5 pcs
			Kg. 18,500	m <sup>3</sup> 0,063



## Ybò

**Cod. 2FSE182041**

Ciliegio  
Cherry

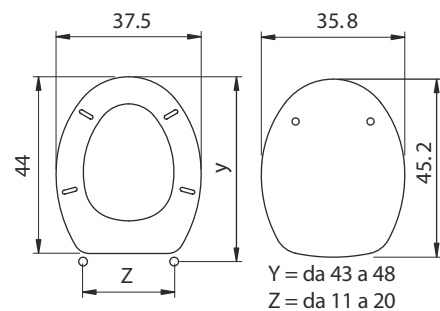

Kg. 3,550	Kg. 3,700	m <sup>3</sup> 0,013	5 pcs	5 pcs
			Kg. 18,500	m <sup>3</sup> 0,063



## Ybò

**Cod. 2FSE182013**

Faggio  
Beech

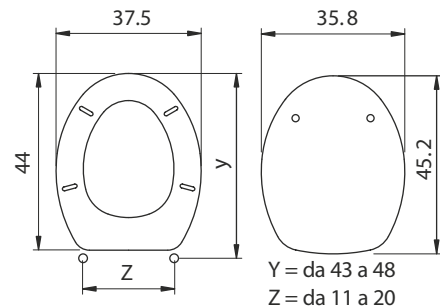

Kg. 3,550	Kg. 3,700	m <sup>3</sup> 0,013	5 pcs	5 pcs
			Kg. 18,500	m <sup>3</sup> 0,063



**Ybò**  
Cod. 2FSE182042F1  
Noce scuro  
Dark walnut

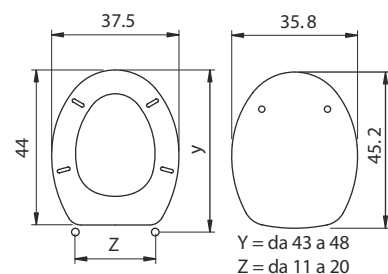

Kg. 3,550	Kg. 3,700	m <sup>2</sup> 0,013	5 pcs	5 pcs
			Kg. 18,500	m <sup>2</sup> 0,063



**Ybò**  
Cod. 2FSE182003F1  
Rovere  
Oak

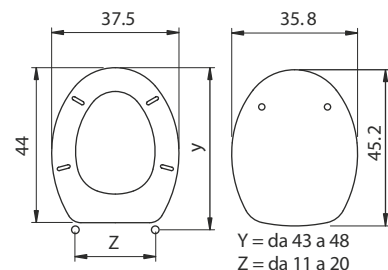

Kg. 3,550	Kg. 3,700	m <sup>2</sup> 0,013	5 pcs	5 pcs
			Kg. 18,500	m <sup>2</sup> 0,063



**Ybò**  
Cod. 2FSE182000F1  
Rovere sbiancato  
Ash

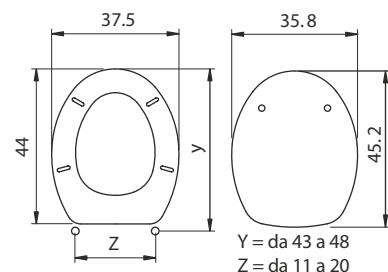

Kg. 3,550	Kg. 3,700	m <sup>2</sup> 0,013	5 pcs	5 pcs
			Kg. 18,500	m <sup>2</sup> 0,063



**Ybò**  
Cod. 2FSE182001F1  
Wengè  
Wengè

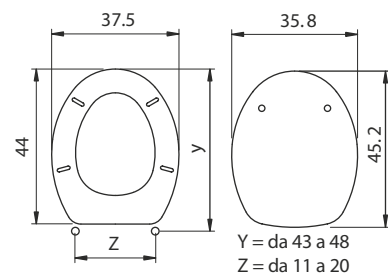

Kg. 3,550	Kg. 3,700	m <sup>2</sup> 0,013	5 pcs	5 pcs
			Kg. 18,500	m <sup>2</sup> 0,063

Sedili wc dedicati in legno mdf FSC®  
Specific toilet seats in FSC® mdf



### ARETUSA

Cod. 2FSE189902F1

Bianco Europeo  
Std. white

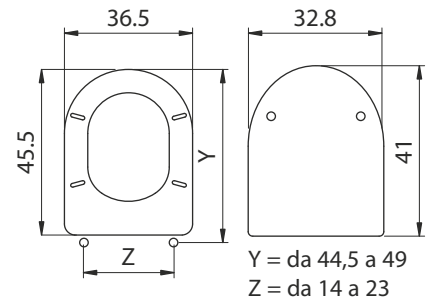

Kg. 3,170	Kg. 3,440	m³ 0,011	5 pcs	5 pcs
			Kg. 18,500	m³ 0,065



### COLIBRI' 2

Cod. 2FSE196602F1

Bianco Europeo  
Std. white

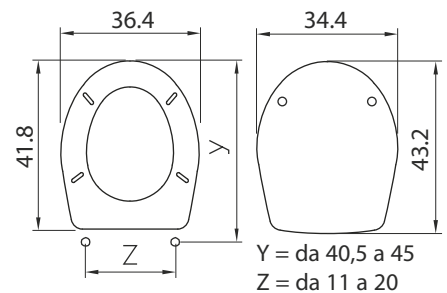

Kg. 2,500	Kg. 2,800	m³ 0,010	5 pcs	5 pcs
			Kg. 16,900	m³ 0,061



### Adatto a CONCA

Cod. 2FSE190002F1

Bianco Europeo  
Std. white

Disponibile anche in:  
Available also in :

Bianco / Ideal Standard White

Cod. 2FSE190059F1

Champagne / Champagne

Cod. 2FSE190008F1

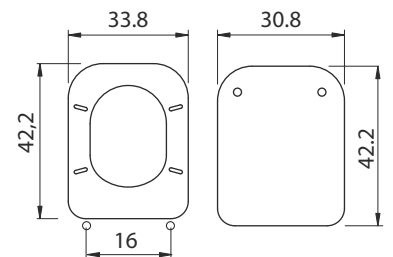

Kg. 2,630	Kg. 2,920	m³ 0,012	5 pcs	5 pcs
			Kg. 15,520	m³ 0,073

Sedili wc dedicati in legno mdf FSC®  
 Specific toilet seats in FSC® mdf



Adatto a **ELLISSE**

**Cod. 2FSE181802F1**

Bianco Europeo  
 Std. white

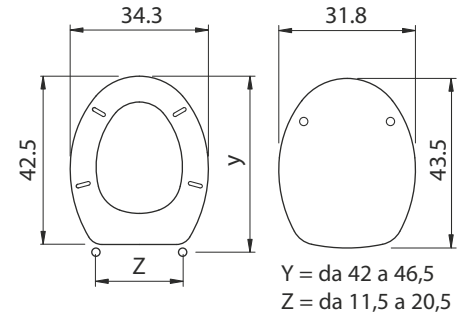

Kg. 2,670	Kg. 2,930	m³ 0,009	5 pcs	5 pcs
			Kg. 15,450	m³ 0,053



Adatto a **ESEDRA**

**Cod. 2FSE190102F1**

Bianco Europeo  
 Std. white

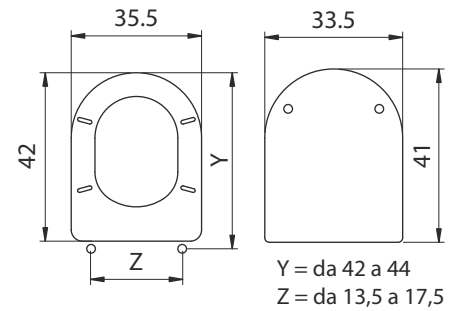

Kg. 2,880	Kg. 3,110	m³ 0,009	5 pcs	5 pcs
			Kg. 16,500	m³ 0,057



**FLEO**

**Cod. 2FSE201202F1**

Bianco Europeo  
 Std. white

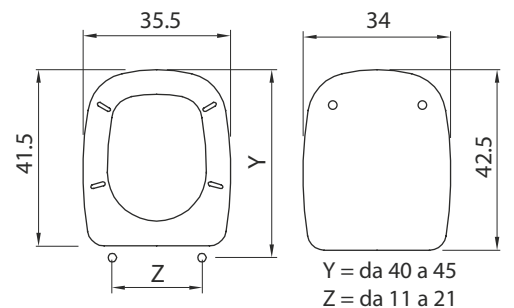

Kg. 2,500	Kg. 2,770	m³ 0,009	5 pcs	5 pcs
			Kg. 14,390	m³ 0,055



Sedili wc dedicati in legno mdf FSC®  
 Specific toilet seats in FSC® mdf



### Adatto a LIUTO

Cod. 2FSE188002F1

Bianco Europeo  
 Std. white

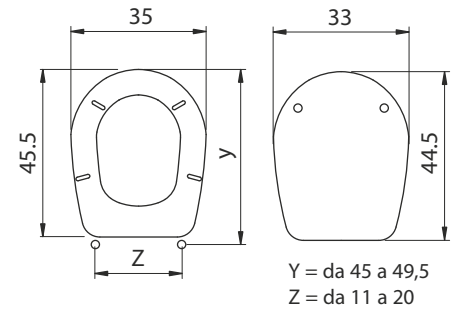

Kg. 2,620	Kg. 2,880	m³ 0,0107	5 pcs	5 pcs
			Kg. 16,000	m³ 0,064



### PIEMONTE

Cod. 2FSE189802F1

Bianco Europeo  
 Std. white

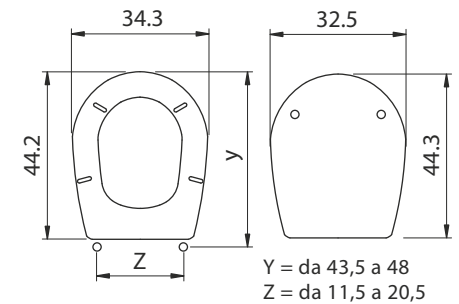

Kg. 2,870	Kg. 3,130	m³ 0,009	5 pcs	5 pcs
			Kg. 16,450	m³ 0,053



### SELNOVA 3

Cod. 2FSE204202F1

Bianco Europeo  
 Std. white

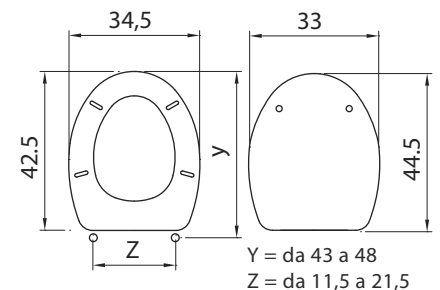

Kg. 3,000	Kg. 3,100	m³ 0,0107	5 pcs	5 pcs
			Kg. 16,200	m³ 0,064

Sedili wc dedicati in legno mdf FSC®  
Specific toilet seats in FSC® mdf



**SINTESI**

**Cod. 2FSE189102F1**

Bianco Europeo  
Std. white

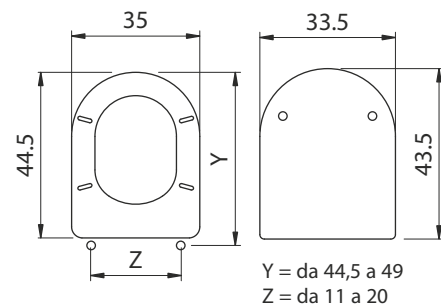

Kg. 3,220	Kg. 3,500	m³ 0,0107	5 pcs	5 pcs
			Kg. 18,300	m³ 0,064



**SQUARE**

**Cod. 2FSE201302F1**

Bianco Europeo  
Std. white

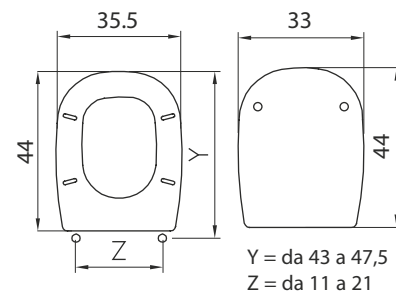

Kg. 3,050	Kg. 3,450	m³ 0,010	5 pcs	5 pcs
			Kg. 17,800	m³ 0,062



**Adatto a TESI**

**Cod. 2FSE189002F1**

Bianco Europeo  
Std. white

Disponibile anche in:  
Available also in :

Bianco / Ideal Standard White

**Cod. 2FSE189059F1**

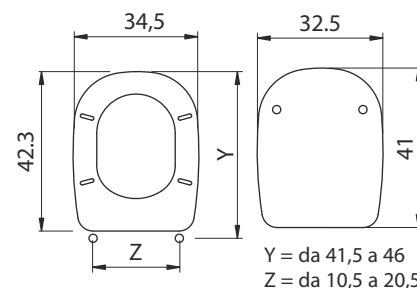

Kg. 2,480	Kg. 2,720	m³ 0,009	5 pcs	5 pcs
			Kg. 14,700	m³ 0,059

Sedili wc in legno mdf decorati 3D  
Decorated mdf toilet seats

**CAR**  
Cod. 2FSE204900



**3D**  
**EFFECT**

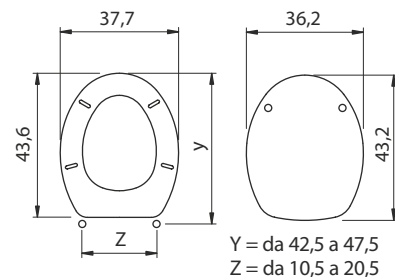

Kg. 2,850	Kg. 3,050	m <sup>3</sup> 0,0106	2 pcs	2 pcs
			Kg. 6,800	m <sup>3</sup> 0,028

**FROG**  
Cod. 2FSE155800



**3D**  
**EFFECT**

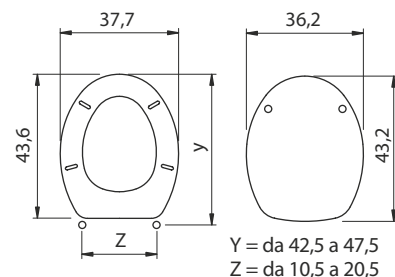

Kg. 2,850	Kg. 3,050	m <sup>3</sup> 0,0106	2 pcs	2 pcs
			Kg. 6,800	m <sup>3</sup> 0,028

**NEW YORK**  
Cod. 2FSE155300



**3D**  
**EFFECT**

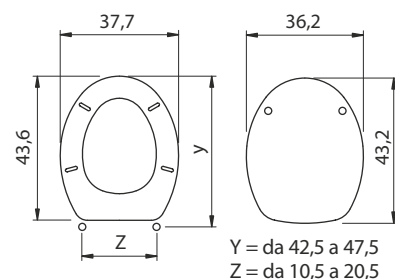

Kg. 2,850	Kg. 3,050	m <sup>3</sup> 0,0106	2 pcs	2 pcs
			Kg. 6,800	m <sup>3</sup> 0,028

Sedili wc in legno mdf decorati 3D  
Decorated mdf toilet seats

**ROMANTIC**

Cod. 2FSE156000



**3D  
EFFECT**

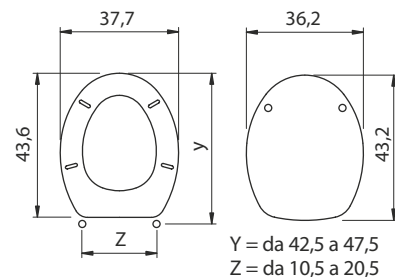

Kg. 2,850	Kg. 3,050	m <sup>2</sup> 0,0106	2 pcs	2 pcs
			Kg. 6,800	m <sup>3</sup> 0,028

**VESPA**

Cod. 2FSE205000



**3D  
EFFECT**

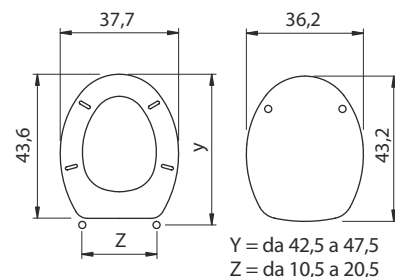

Kg. 2,850	Kg. 3,050	m <sup>2</sup> 0,0106	2 pcs	2 pcs
			Kg. 6,800	m <sup>3</sup> 0,028

**CHARME CRÈME**

Cod. 2FSE156553F1

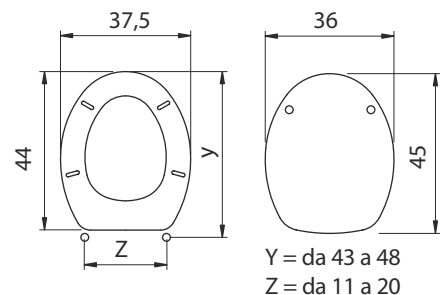

Kg. 3,510	Kg. 3,750	m <sup>2</sup> 0,0106	3 pcs	3 pcs
			Kg. 11,710	m <sup>3</sup> 0,039

Sedili wc in legno mdf decorati 3D  
Decorated mdf toilet seats



**CHARME ROUGE**

Cod. 2FSE156504F1

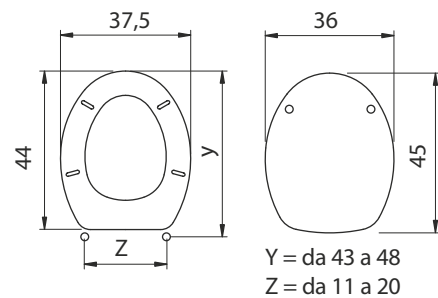

Kg. 3,510	Kg. 3,750	m <sup>2</sup> 0,0106	3 pcs	3 pcs
			Kg. 11,710	m <sup>2</sup> 0,039



**ROCOCO' LILLA**

Cod. 2FSE157164F1

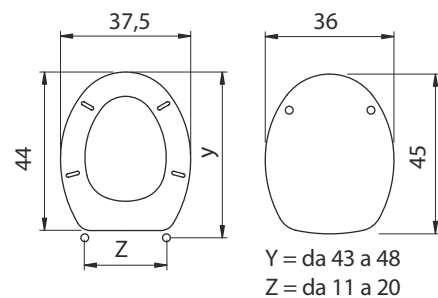

Kg. 3,510	Kg. 3,750	m <sup>2</sup> 0,0106	3 pcs	3 pcs
			Kg. 11,710	m <sup>2</sup> 0,039

**PARTE TECNICA INFORMATIVA DELLE ADATTABILITÀ DEI SEDILI WC  
ADAPTABILITY AND TECHNICAL INFORMATION FOR WC SEATS**



Termoindurente - Duroplast

AP

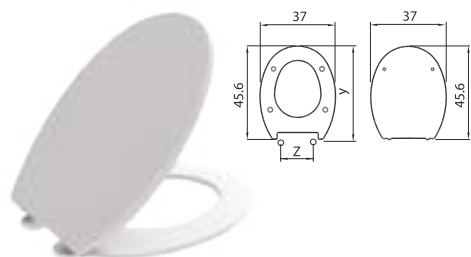

Cod. 2FSE209902

H481 | Y = da 41,5 a 47,5  
Z = da 9,5 a 21,5



REVERSE

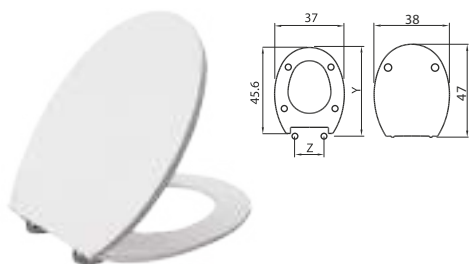

Cod. 2FSE029502

H481 | Y = da 41,5 a 47,5  
Z = da 9,5 a 21,5



SHAPE

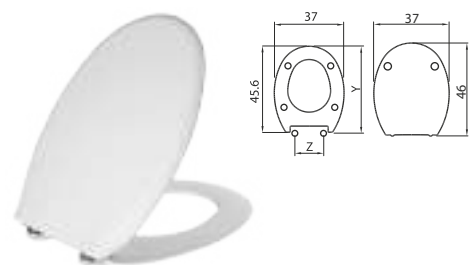

Cod. 2FSE029602

H481 | Y = da 41,5 a 47,5  
Z = da 9,5 a 21,5



Termoindurente - Duroplast

VERSO

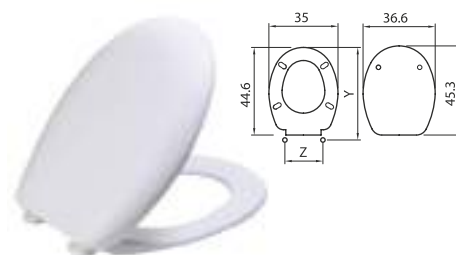

cod. 2FSE166302

H057 | Y = da 42,3 a 46,0  
Z = da 13,3 a 17,8



cod. 2FSE161202

H011 | Y = da 43,0 a 44,9  
Z = da 12,3 a 17,9



cod. 2FSE174302

H306 | Y = da 43,0 a 44,9  
Z = da 12,3 a 17,9



Z0

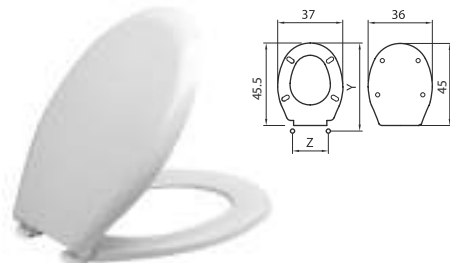

cod. 2FSE014702

H011 | Y = da 43,5 a 45,6  
Z = da 11,7 a 17,4



cod. 2FSE014802

H306 | Y = da 43,5 a 45,6  
Z = da 11,7 a 17,4



Poliestere/Polyester "Sanilux"

P01 - UNIVERSALE

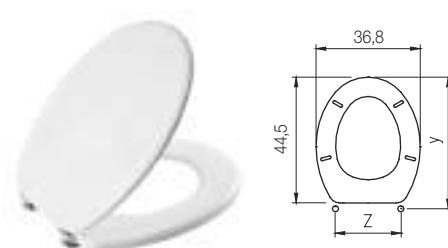

cod. 2FSE120002

UNI NS | Y = da 41,5 a 46,5  
Z = da 12,5 a 21,5



Fissaggio con tirante e galletto  
Fixing with screw and nut

Paracolpi TR10 (x4)

P01 - GANCIO

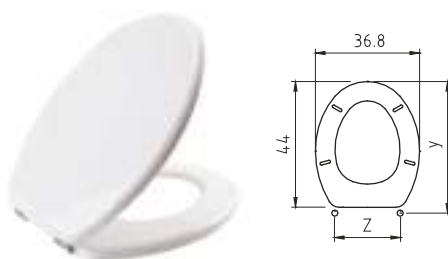

cod. 2FSE140102

GANCIO | Y = da 43 a 45,5 cm  
Z = da 16 a 21,8 cm



Fissaggio con tirante e galletto  
Fixing with screw and nut

**Legno e legno Mdf  
Wood & Mdf**

**YBO'**

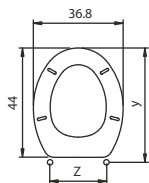

cod. 2FSE182002F1



Y = da 42,5 a 47,5  
Z = da 11,0 a 21,0

**START**

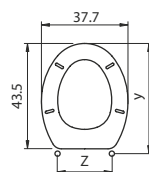

cod. 2FSE187002F1



Y = da 41,5 a 46,5  
Z = da 10,5 a 20,5

**SITO**

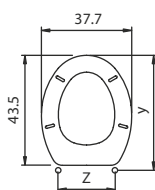

cod. 2FSE198802F1



Y = da 41,5 a 46,5  
Z = da 10,5 a 20,5



Althea(Sanitalia)	Cento	Gravena	Jenny
Althea(Sanitalia)	Hola	Hatria-Spea	Amalfi
Archiade	Fausta	IdealStandard	Ponti
Archiade	Flaminia	Ilca	Micene
Archiade	Fulvia	Ilca	Tebe
Artigianato Ceramico	Duna	Incea	Supra
Artigianato Ceramico	Ghibli	Olympia	Ambra
Artigianato Ceramico	Oasi	PozziGinori	Arcobaleno
Astra	Impero MB	PozziGinori	Aura
Astra	Olimpia	PozziGinori	Aurora
Axa	Mirto	PozziGinori	Cervinia
Azzurra	Alba	PozziGinori	Curva
Azzurra	Giove	PozziGinori	Elios
Catalano	Luce	PozziGinori	Europa
Ceramica Cielo	Ermes	PozziGinori	Fantasia
Cesabo	Alexandra	PozziGinori	Gardena
Cesabo	Alessandro	PozziGinori	Ginepro
Cesabo	Elite	PozziGinori	Idro
Cesame	Simplex	PozziGinori	Modulo
Cierre	Ortisei	PozziGinori	Selnova
Delta	Oceano New	PozziGinori	Selva
Delta	Raffaello	PozziGinori	Tabor
Duravit	Architec	PozziGinori	Torcello
Duravit	Darling	Rak	Karla
Duravit	Laconda	Roca	Neo Victoria
Duravit	Speciale	Sbordoni	Flaminia
Eos-Simca	Cimino	Scala	Friuli
Eos-Simca	Jolly	Scala	Longa
Eos-Simca	Orchidea	Scala	Primavera
Eos-Simca	Tulipano	Scala	Rugiada
Etruria	Sirio	Scala	Tau
Euroceramiche	Iris	Senesi	Brunello
Falerii	Gaia	Senesi	Leonardo
Falerii	Novella	Senesi	Michelangelo
Falerii	Sabrina	Simas	Alfa
Flaminia	Arena	Simas	Beta
Flaminia	Pompei	Simas	Deborah
G.S.G.	Alfa	Simas	Eco
G.S.G.	Atene	Simas	Gatteo
G.S.G.	Roma	Simas	Montezuma
G.S.I.	Garda	Tenax-Simi	Airone
G.S.I.	Giada	Tenax-Simi	Vega
G.S.I.	Iseo	Vincenti	Milano
G.S.I.	Lugano	Vitruvit-Profil	Calipso
G.S.I.	Modo	Vitruvit-Profil	Lady
G.S.I.	Topazio	Vitruvit-Profil	Minerva
Galassia	Olà	Vitruvit-Profil	Partenone
Galassia	Vera	Vitruvit-Profil	Partenone MB
Globo	Arianna	Vitruvit-Profil	Sky3
Gravena	Derby	Vitruvit-Profil	Sprint



Termoindurente - Duroplast

DOUBLE



Cod. 2FSE192402

DOUBLE | Z = 16



Cod. 2FSE183702

DOUBLE | Z = 16



Poliestere- Polyester "Sanilux"

P02

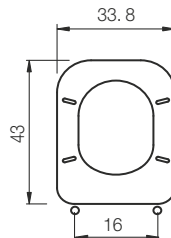

cod. 2FSE140259

CONCA | Z = 16



Fissaggio con tirante e galleggio  
Fixing with screw and nut

Paracolpi anteriori SAGOMA A (x2)  
Paracolpi posteriori TD 12 (X2)

Legno e legno Mdf  
Wood & Mdf

adatto a CONCA

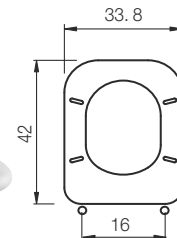

cod. 2FSE190002F1

CONCA | Z = 16



Artigianato Ceramico	Rex	G.S.I.	Traccia	Scic	Maxi lusso
Cierre Sanitari	Cortina	Gravena	Conny	Senesi	Duccio
Cesabo	Prestige	Hidra	Montreal	Vincenti	Versilia
Etruria	Etruria	Ideal Standard	Conca	Vitruvit-Profilo	Florida MB
Euroceramiche	Gioia	Isvea	C.O.	Vitruvit-Profilo	Gronda
Falerii	Medina	Nero Ceramica	Aliseo	Vitruvit-Profilo	Pella
G.S.I.	Vela	Nero Ceramica	Aliso sospeso		

## CW03 FIORILE/LINDA vaso a terra/floor pan wc

**Termoindurente - Duroplast**

**LINDA terra / PASSEPARTOUT**



cod. 2FSE161402

H011 | Y = da 42,8 a 44,6  
 Z = da 12,6 a 18,3



cod. 2FSE175502

H323 | Y = da 41,6 a 46,3  
 Z = da 8,7 a 18,8



**Poliestere- Polyester "Sanilux"**

**P03**

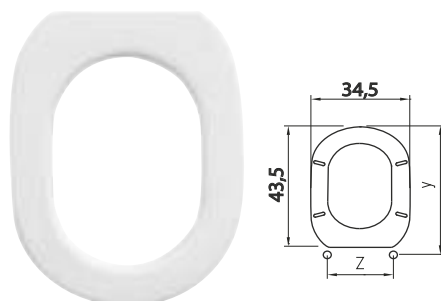

cod. 2FSE140359

UNI NS | Y = da 41,5 a 46,5  
 Z = da 12,5 a 21,5



Fissaggio con tirante e galletto  
 Fixing with screw and nut

Paracolpi RT10 (x4)

## CW03 FIORILE/LINDA vaso sospeso / wall hung

**Termoindurente - Duroplast**

**LINDA sosp / LUNA 2**



cod. 2FSE000502

H050 | Y = da 42,5 a 47,7  
 Z = da 11,7 a 22,2



cod. 2FSE000802

H323 | Y = da 42,3 a 47,3  
 Z = da 11,1 a 21,1



**Poliestere- Polyester "Sanilux"**

**P03**

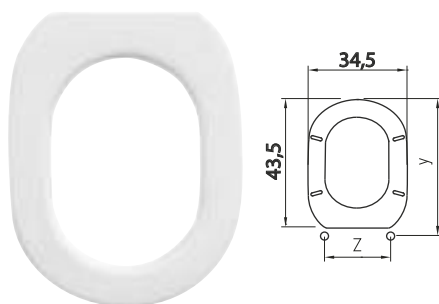

cod. 2FSE140359

UNI NS | Y = da 41,5 a 46,5  
 Z = da 12,5 a 21,5



Fissaggio con tirante e galletto  
 Fixing with screw and nut

Paracolpi RT10 (x4)

**Legno e legno Mdf  
 Wood & Mdf**

**adatto a ESEDRA**

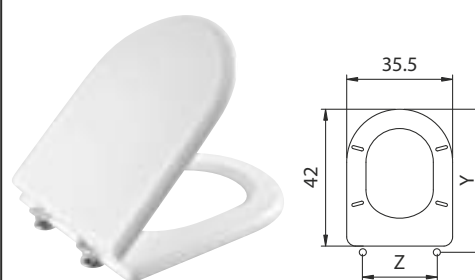

cod. 2FSE190102F1

Y = da 41,5 a 44,0  
 Z = da 13,5 a 17,5



Eos-Simca	Punto	Ideal Standard	Linda sospeso	Tenax	Alba
Eos-Simca	Riace-Segesta	Ideal Standard	Fiorile	Senesi	Tuscia
Ideal Standard	Linda	Pozzi Ginori	Linea		

## CW04 LIUTO

**Termoindurente - Duroplast**

**MITHO / LIUTO**



cod. 2FSE002202

H011 | Y = da 43,6 a 45,3  
Z = da 12,8 a 18,4

cod. 2FSE002402

H057 | Y = da 43,3 a 47,0  
Z = da 13,4 a 17,9



**Poliestere- Polyester "Sanilux"**

**P04**

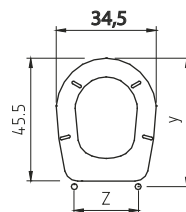

cod. 2FSE140459

UNI NS | Y = da 42 a 47  
Z = da 13,5 a 22,5



Fissaggio con tirante e galletto  
Fixing with screw and nut

Paracolpi RT10 (x4)

**Legno e legno Mdf  
Wood & Mdf**

**adatto a LIUTO**

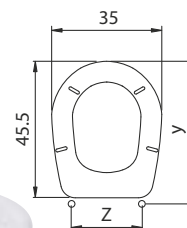

cod. 2FSE188002F1

Y = da 43,5 a 49  
Z = da 11 a 21



Gravena	Rhonda	Ideal Standard	Liuto	Scala	Tanga
Gravena	Sisma				

## CW05 TESI

**Legno e legno Mdf  
Wood & Mdf**

**Termoindurente - Duroplast**

**FIVE**



cod. 2FSE172702

H025S | Y = da 42 a 43,1  
Z = da 15,5 a 16,5

cod. 2FSE172802

H306 | Y = da 41,5 a 43,5  
Z = da 12 a 18



**Poliestere- Polyester "Sanilux"**

**P05**

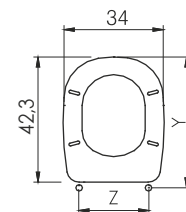

cod. 2FSE140559

UNI NS | Y = da 41,5 a 46,5  
Z = da 12,5 a 21,5



Fissaggio con tirante e galletto  
Fixing with screw and nut

Paracolpi RT10 (x4)

**adatto a TESI**

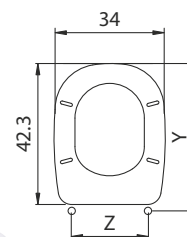

cod. 2FSE189002F1

Y = da 40 a 45  
Z = da 11,5 a 21,5



Cifal	Eden	Ideal Standard	Tesi	Senesi	Pienza
G.S.I.	X2	Sanex	Tania	Vincenti	Curva

**Termoindurente - Duroplast**

**TANGO / ELLISSE**



cod. 2FSE009602

H011 | Y = da 42,7 a 44,7  
Z = da 12,8 a 17,9



cod. 2FSE172102

H057 | Y = da 41,8 a 45,6  
Z = da 12,1 a 16,7



**Poliestere- Polyester "Sanilux"**

**P06**

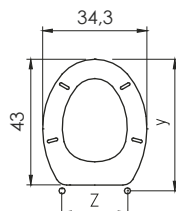

cod. 2FSE140659

UNI NS | Y = da 40,5 a 45  
Z = da 10,5 a 19,5



**Fissaggio con tirante e galletto**  
**Fixing with screw and nut**

**Paracolpi RT10 (4X)**

**Legno e legno Mdf**  
**Wood & Mdf**

**adatto a ELLISSE**

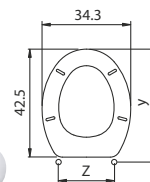

cod. 2FSE181802F1



Y = da 41,5 a 46,5  
Z = da 11,5 a 21,5

Archiade	Ottocento	Eos	Stylon	Kerasan	Luna
Astra	Lido	Hatria Spea	Cannes	Kerasan	Jolly
Astra	Trio	Hatria Spea	Ediliza	Pozzi Ginori	Idro
Azzurra	Aris	Ideal Standard	Ellisse più	Pozzi Ginori	Mini
Azzurra	Giove	Ideal Standard	Ellisse	Pozzi Ginori	Murano
Catalano	Junior	Ideal Standard	Iril	Pozzi Ginori	Omnia
Cielo	Roma	Ideal Standard	Zanvas	Senesi	Donatello
Dolomite	Perla Classic	Incea	Jo	Scala	Rugiada
Duravit	Dune	Kerasan	Europa	Scic	Up (S02)
Eos	Primula				

## CW07 SQUARE

**Poliestere- Polyester "Sanilux"**

**P07**

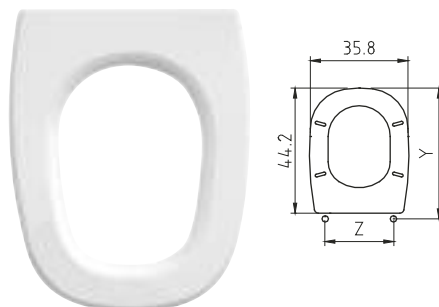

cod. 2FSE140702

UNI NS | Y= da 41,5 a 46,5  
Z= da 12,5 a 21,5



Fissaggio con tirante e galletto  
Fixing with screw and nut

Paracolpi RT10 (4X)

**Legno e legno Mdf  
Wood & Mdf**

**SQUARE**

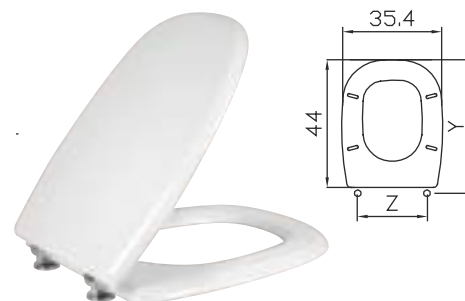

cod. 2FSE201302F1



Y = da 43 a 48  
Z = da 11 a 21

Pozzi Ginori

Square

Hatria-Spea

Lisa

## CW09 PIEMONTE

**Poliestere- Polyester "Sanilux"**

**P09**

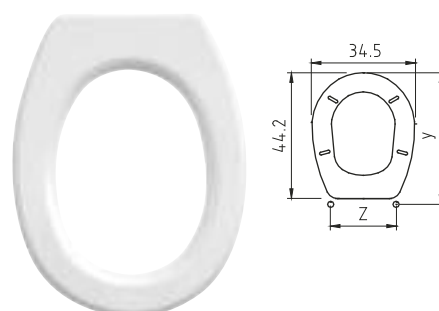

cod. 2FSE140902

UNI NS | Y= da 41,5 a 46,5  
Z= da 12,5 a 21,5



Fissaggio con tirante e galletto  
Fixing with screw and nut

Paracolpi RT10 (4X)

**Legno e legno Mdf  
Wood & Mdf**

**PIEMONTE**

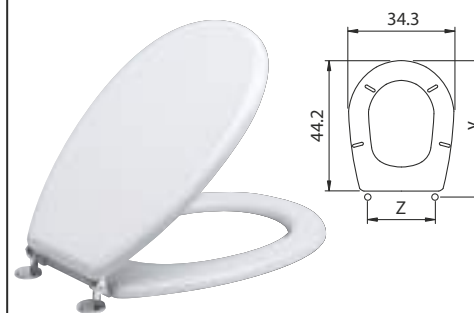

cod. 2FSE189802F1



Y = da 43 a 48  
Z = da 11,5 a 21,5

Globo

Pascha

Sanitosco

Polifemo Mini

Senesi

Guelfa

Pozzi Ginori

Piemonte

Sanitosco

Sanithan

Pozzi Ginori

Piemontesina

Sanitosco

Up

## CW10 CLODIA

Termoindurente - Duroplast

LUNA 2



cod. 2FSE000502

H050 | Y = da 42,5 a 47,7  
Z = da 11,7 a 22,2

cod. 2FSE000802

H323 | Y = da 42,3 a 47,3  
Z = da 11,1 a 21,1



Dolomite

Clodia

Poliestere- Polyester "Sanilux"

P10

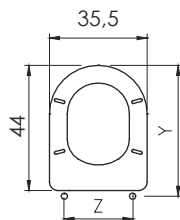

cod. 2FSE141002

UNI NS | Y = da 41,5 a 46,5  
EXP. L. | Z = da 12,5 a 21,5



Fissaggio con espansore  
Fixing with expansion

Paracolpi RT10 (4X)

Dolomite

Clodia MB

Legno e legno Mdf  
Wood & Mdf

Adatto a ESEDRA

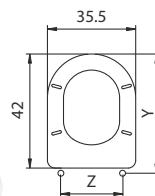

cod. 2FSE190102F1

Y = da 41,5 a 44,0  
Z = da 13,5 a 17,5



## CW11 SINTESI

Termoindurente - Duroplast

LUNA



cod. 2FSE165802

H057 | Y = da 42,8 a 47,2  
Z = da 16,0 a 20,2



Cesame

Sintesi

Poliestere- Polyester "Sanilux"

P11

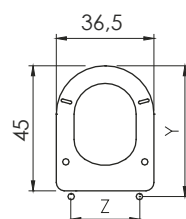

cod. 2FSE141102

UNI NS | Y = da 41,5 a 46,5  
Z = da 12,5 a 21,5



Fissaggio con tirante e galletto  
Fixing with screw and nut

Paracolpi anteriori sagoma B (2X)  
Paracolpi posteriori TD10 (2x)

Legno e legno Mdf  
Wood & Mdf

SINTESI

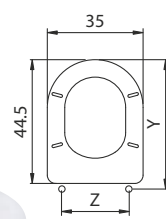

cod. 2FSE189102F1

Y = da 43,5 a 49  
Z = da 11 a 21



**Termoindurente - Duroplast**

**LUNA 2**



cod. 2FSE202802

H057 | Y = da 42,8 a 47,2  
Z = da 16,0 a 20,2



cod. 2FSE000802

H323 | Y = da 42,3 a 47,3  
Z = da 11,1 a 21,1



**Poliestere- Polyester "Sanilux"**

**P12 - ALTHEA**

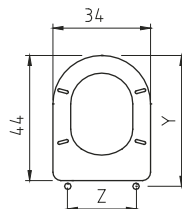

cod. 2FSE141202

UNI NS | Y = da 41,5 a 46,5  
Z = da 12,5 a 21,5



**Fissaggio con tirante e galletto**  
**Fixing with screw and nut**

**Paracolpi RT10 (4X)**

Althea (Sanitalia)	Althea	Azzurra	Venere	Globo	Alia
Althea (Sanitalia)	Marea	Catalano	Odeon	Gravena	Garbo
Althea (Sanitalia)	Marion	Ceramica Cielo	Ares	Hidra	Top line
Althea (Sanitalia)	Melrose	Ceramica Cielo	Celia	Indusa	Alfa
Althea (Sanitalia)	Ring	Cesabo	Endurance	Jumbo	Simpaty
Amerina	Arco	Cierre Sanitari	Okay 2 sospesa	Keratina	Fryni
Amerina	Armony	Delta	Sahara	Keratina	Narkisos
Archiade	Marina	Delta	Solara	Olympia	Rio
Artigianato Ceramico	Croma	Euroceramiche	Valentina	Sanindusa	Alpha
Astra	Divina	Falerii	Tiffany	Sanindusa	Prestige
Astra	Serie 84	Flaminia	Relax	Sbordoni	Marina
Astra	Serie 85	Flaminia	Relax sospesa	Scic	Bella
Axa	Clivia	Flaminia	Valentine Nuovo	Scic	Donna
Axa	Sicilia	G.S.G.	Astra	Scic	L'altra Linea
Axa	Verbena	G.S.G.	Jasmine	Veliero	Odissea
Azzurra	Divina	G.S.I.	Blitz	Vincenti	Tipo
Azzurra	Frine	G.S.I.	Elisa	Vitruvit-Profilo	Fantasia
Azzurra	I Sensi	G.S.I.	Pitti	Vitruvit-Profilo	Stella
Azzurra	Paola				

## CW13 ARETUSA

**Termoindurente - Duroplast**

**AQUA / ARETUSA**



cod. 2FSE202302

H341 | Y = da 40 a 48  
Z = da 6 a 22

cod. 2FSE200002

H323 | Y = da 42 a 46,7  
Z = da 8,7 a 18,8



**Poliestere- Polyester "Sanilux"**

**P13 - ARETUSA**

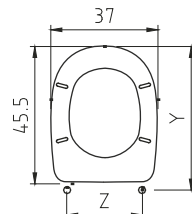

cod. 2FSE141302

UNI NS | Y = da 43 a 47,5  
Z = da 12,5 a 21,5



Fissaggio con tirante e galletto  
Fixing with screw and nut

Paracolpi anteriori Sagoma A (x4)  
Paracolpi posteriori RT12 (x4)

**Legno e legno Mdf  
Wood & Mdf**

**ARETUSA**

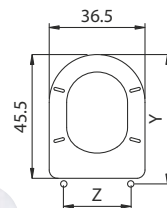

cod. 2FSE189902F1



Y = da 44 a 50  
Z = da 14 a 23

Cesame

Aretusa

## CW14 ARETUSINA

**Termoindurente - Duroplast**

**PASSEPARTOUT**



cod. 2FSE164602

H057 | Y = da 41,8 a 45,7  
Z = da 13,3 a 17,8

cod. 2FSE175502

H323 | Y = da 41,6 a 46,3  
Z = da 8,7 a 18,8



**Poliestere- Polyester "Sanilux"**

**P14**

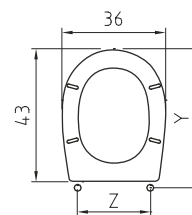

cod. 2FSE141402

UNI NS | Y = da 40,7 a 45,2  
Z = da 12,5 a 21,5



Fissaggio con tirante e galletto  
Fixing with screw and nut

Paracolpi RT10 (x4)

Althea (Sanitalia)	Elena	Duravit	Duraplus	Galvit	Agorà
Catalano	Aria nuovo	Eos-Simca	Clio	Gravena	Giada
Cesame	Aretusa	Flaminia	Metro Sospesa	Indusa	Aveiro
Cesame	Aretusina Sospesa	G.S.I.	Xenia 1	Laufen	Dino sospesa
Cesame	Aretusina MB	Galassia	Piuma		



Poliestere- Polyester "Sanilux"

P15 - RIO

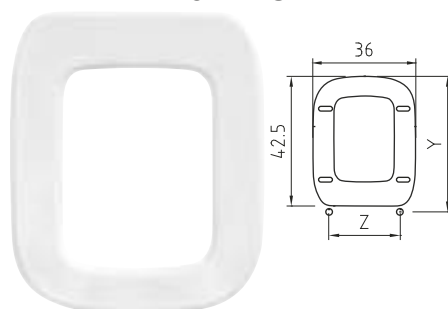

cod. 2FSE141502

UNI NS | Y= da 40,5 a 45  
EXP. L. | Z= da 12,5 a 21,5



Fissaggio con espansore  
Fixing with expansion

Paracolpi RT10 (x4)

Dolomite

Rio

Pozzi Ginori

Q3

CW16 ALPINA

Legno e legno Mdf  
Wood & Mdf

Termoindurente - Duroplast

LUNA 2



cod. 2FSE000502

H050 | Y = da 42,5 a 47,7  
| Z = da 11,7 a 22,2



Poliestere- Polyester "Sanilux"

P16

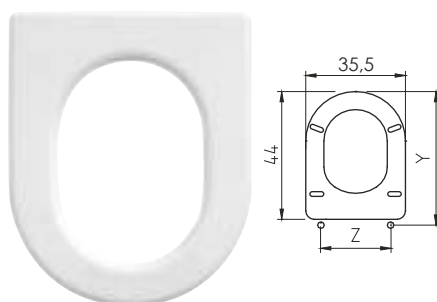

cod. 2FSE141602

UNI NS | Y= da 41,5 a 46,5  
EXP. L. | Z= da 12,5 a 21,5



Fissaggio con espansore  
Fixing with expansion

Paracolpi RT10 (x4)

adatto a ESEDRA

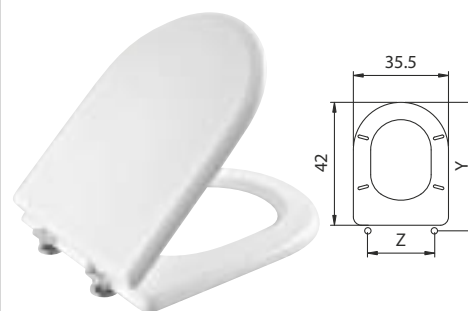

cod. 2FSE190102F1

Y = da 41,5 a 44,0  
Z = da 13,5 a 17,5



Azzurra

Comoda

Dolomite

Quadrarco

Falerii

H2O

Dolomite

Alpina

Cielo

Enjoy

Vitra

S50

## CW17 AFRODITE

**Termoindurente - Duroplast**

**AQUA**



cod. 2FSE202302

H341 | Y = da 40 a 48  
Z = da 6 a 22

cod. 2FSE200002

H323 | Y = da 42 a 46,7  
Z = da 8,7 a 18,8



**Poliestere- Polyester "Sanilux"**

**P17 - AFRODITE**

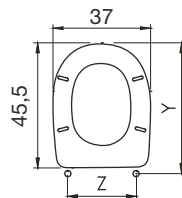

cod. 2FSE141702

UNI NS | Y = da 43 a 47,5  
Z = da 12,5 a 21,5



Fissaggio con tirante e galletto  
Fixing with screw and nut

Paracolpi RT10 (x4)

**Legno e legno Mdf  
Wood & Mdf**

**ARETUSA**

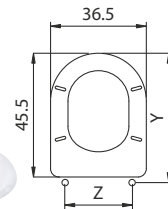

cod. 2FSE189902F1

Y = da 44 a 50  
Z = da 14 a 23



Althea (Sanitalia)	Cora	Eos-Simca	Flower	Globo	Open Space sos.
Althea (Sanitalia)	Plaza	Etruria	Alba	Jumbo	Aretha
Althea (Sanitalia)	Rose	Falerii	Adria	Jumbo	Arethona
Azzurra	Afrodite	Falerii	Aida	Kerafina	Lito
Azzurra	Le Onde	Falerii	Giulietta	Kerafina	Vergina
Azzurra	Midas	Flaminia	Metro	Kerasan	Godia
Cierre Sanitari	Super	G.S.G.	Ambra	Senesi	Sovana
Eos-Simca	Armonia				

## CW18 ITALICA

**Poliestere- Polyester "Sanilux"**

**P18 - ITALICA**

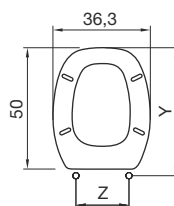

cod. 2FSE141802

UNI NS | Y = da 48 a 52  
Z = da 12,5 a 21,5



Fissaggio con tirante e galletto  
Fixing with screw and nut

Paracolpi RT10 (x4)

Pozzi Ginori	Italica	Vavid	Nordica	Hatria Spea	Gran Sasso
--------------	---------	-------	---------	-------------	------------

Termoindurente - Duroplast

D-CODE



cod. 2FSE055002

D-CODE | Y = 42,2 |  
Z = 16,8



Duravit

D-Code

CW21 ESEDRA

Termoindurente - Duroplast

LUNA 2



cod. 2FSE000502

H050 | Y = da 42,5 a 47,7 |  
Z = da 11,7 a 22,2

cod. 2FSE000802

H323 | Y = da 42,3 a 47,3 |  
Z = da 11,1 a 21,1



Poliestere- Polyester "Sanilux"

P21 - ESEDRA

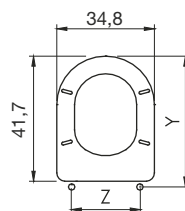

cod. 2FSE142159

UNI NS | Y = da 41,5 a 46,5 |  
EXP. L. | Z = da 12,5 a 21,5



Fissaggio con espansore  
Fixing with expansion

Paracolpi RT10 (4X)

Legno e legno Mdf  
Wood & Mdf

Adatto a ESEDRA

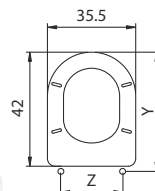

cod. 2FSE190102F1

Y = da 41,5 a 44,0  
Z = da 13,5 a 17,5



Althea (Sanitalia)	Cover	Esedra	Ever	Ideal Standard	Fiorile New
Alice Ceramica	Form	Globo	Open Space Concept	Ideal Standard	Wash point
Archiade	Sospesa	Gravena	Dafne	Globo	Forty 3 (43)
Azzurra	Nuvola	G.S.I.	Pura	Rak	Compact
Catalano	Free	Hatria-Spea	Daytime	Roca	Nexo
Catalano	Sphera vecchio	Ideal Standard	Esedra	Senesi	Tosca
Ceramica Cielo	Smile	Ideal Standard	Fiorile Sospeso	Vitruvit-Profilì	Armonia
Disegno Ceramica	Skip	Ideal Standard	Fiorile Lusso	Vulcano	Classic
Duravit	Erica				

## CW26 DIANA

### Termoindurente - Duroplast

#### AQUA



cod. 2FSE202302

H341 | Y = da 40 a 48  
 Z = da 6 a 22

cod. 2FSE200002

H323 | Y = da 42 a 46,7  
 Z = da 8,7 a 18,8



### Poliestere- Polyester "Sanilux"

#### P26 - DIANA

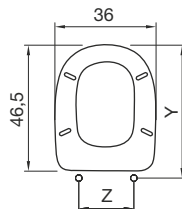

cod. 2FSE142602

UNI NS | Y = da 44,5 a 48,5  
 Z = da 12,5 a 21,5



Fissaggio con tirante e galletto  
 Fixing with screw and nut

Paracolpi RT10 (x4)

Flaminia	Isabel
Globo	Grace
Globo	Flavia (Alia)
Gravena	Pendy
Hidra	Onda
Hidra	Pegaso
Jumbo	Tua
Kerasan	Elka
Roca	Zoom
Sbordoni	Sospesa
Simas	Modulo
Simas	Primavera
Simas	Selenia
Vincenti	Farah
Vincenti	Uno

Astra	Gemma
Astra	Hi-fi
Astra	Mia
Astra	Serie 83
Axa	Axa2
Azzurra	Diana
Azzurra	Elena
Azzurra	Elios

Azzurra	Giulia MB
Azzurra	Novecento
Azzurra	Ottocento
Cierre Sanitari	Desirée
Cierre Sanitari	Piuma
Duravit	Nube
Eos-Simca	Astro
Eos-Simca	Ola

## CW27 CINQUECENTO

### Poliestere- Polyester "Sanilux"

#### P27 - CINQUECENTO

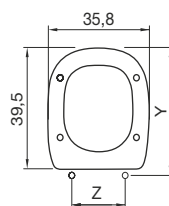

cod. 2FSE142702

UNI NS  
 EXP. L. | Y = da 37,5 a 41,5  
 Z = da 12,5 a 21,5



Fissaggio con espansore  
 Fixing with expansion

Paracolpi RT10 (4X)

Pozzi Ginori

Cinquecento

Termoindurente - Duroplast

MAMBO



cod. 2FSE009202

H050 | Y = da 42,2 a 47,7 |  
 Z = da 9,5 a 19,5



Dolomite

Corallo

G.S.I.

Essenza

CW30 POLO

Termoindurente - Duroplast

SAMBA

SEBINO



2FSE007402 (SAMBA)

H011 | Y = da 42,7 a 45,0 |  
 Z = da 13 a 17,9

2FSE158602 (SAMBA)

H057 | Y = da 42,4 a 45,7 |  
 Z = da 14,1 a 18,7

2FSE005902 (SEBINO)

H011 | Y = da 42,7 a 45,0 |  
 Z = da 13 a 17,9

2FSE015902 (SEBINO)

H057 | Y = da 42,4 a 45,7 |  
 Z = da 14,1 a 18,7



Poliestere- Polyester "Sanilux"

P30 - POLO

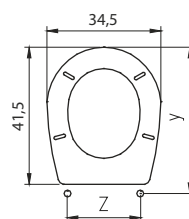

cod. 2FSE143002

UNI NS | Y = da 39,5 a 43,5 |  
 Z = da 12,5 a 21,5



Fissaggio con tirante e galletto  
 Fixing with screw and nut

Paracolpi RT10 (x4)

Legno e legno Mdf  
 Wood & Mdf

COLIBRI'

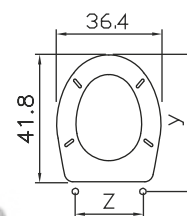

cod. 2FSE196602F1

Y = da 40 a 45  
 Z = da 10 a 20



Catalano	Taormina	Pozzi Ginori	Colibri'	Scala	Gemma
Dolomite	Cristallo	Pozzi Ginori	Ilgarda	Simas	Lory
Dolomite	Quarzo	Pozzi Ginori	Kim	Vitra	Architet sosp
Eos-Simca	Medea	Pozzi Ginori	Monviso	Vitruvit-Profilii	Diana
Falerii	Thermae	Roca	Polo		

## CW32 BELLE EPOQUE

Legno e legno Mdf  
Wood & Mdf

Termoindurente - Duroplast

PASSEPARTOUT



cod. 2FSE166402

H050 | Y = da 40,9 a 46,3  
Z = da 9,3 a 19,4

cod. 2FSE175502

H323 | Y = da 41,6 a 46,3  
Z = da 8,7 a 18,8



Poliestere- Polyester "Sanilux"

P32 - BELLE EPOQUE

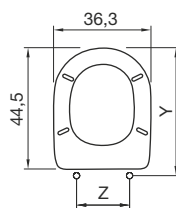

cod. 2FSE143202

UNI NS | Y = da 43 a 47,5  
Z = da 12,5 a 21,5



Fissaggio con tirante e galletto  
Fixing with screw and nut

Paracolpi RT10 (4X)

SINTESI

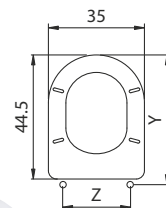

cod. 2FSE189102F1

Y = da 43,5 a 49  
Z = da 11 a 21



Cesame	Belle Epoque	Isvea	Monika	Vitruvit-Profil	Alessandra
Disegno Ceramica	Giulia	Keratina	Millenium	Vitruvit-Profil	Maiorca
G.S.I.	Davina	Simas	Europa 2 vers.	Vulcano	Primavera
Galvit	Miro'	Vincenti	Antica		
Hidra	Memory				

## CW43 CALLA

Poliestere- Polyester "Sanilux"

P43 - CALLA

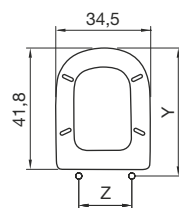

cod. 2FSE144359

UNI NS | Y = da 39,5 a 44  
Z = da 12,5 a 21,5



Fissaggio con tirante e galletto  
Fixing with screw and nut

Paracolpi RT10 (x4)

Dolomite	Gemma Due	Ideal Standard	Calla
----------	-----------	----------------	-------

**Termoindurente - Duroplast**

**TERRA**



cod. 2FSE001602

H050 | Y = da 42,5 a 47,7 |  
 Z = da 11,7 a 22,2

cod. 2FSE001002

H323 | Y = da 42,7 a 47,2 |  
 Z = da 11,2 a 21,2



**Termoindurente - Duroplast**

**ARIA**



cod. 2FSE203102

H050 | Y = da 41,5 a 46,7 |  
 Z = da 12,0 a 22,5

cod. 2FSE200302

H323 | Y = da 41,7 a 46,2 |  
 Z = da 11,5 a 21,5



Flaminia

App

Flaminia

Quick

Ideal Standard

Absolute Kurokawa

**CW49 NOVECENTO**

**Termoindurente - Duroplast**

**PASSEPARTOUT**



cod. 2FSE164602

H057 | Y = da 41,8 a 45,7 |  
 Z = da 13,3 a 17,8



Cesame

900

Pozzi Ginori

Selnova 3

Termoindurente - Duroplast

PASSEPARTOUT



cod. 2FSE166402

H050 | Y = da 40,9 a 46,3  
Z = da 9,3 a 19,4



cod. 2FSE175502

H323 | Y = da 41,6 a 46,3  
Z = da 8,7 a 18,8



Poliestere- Polyester "Sanilux"

P60 - EASY

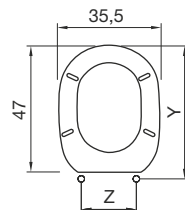

cod. 2FSE146002

UNI NS | Y = da 44,8 a 49,2  
EXP. L. | Z = da 12,5 a 21,5



Fissaggio con espansore  
Fixing with expansion

Paracolpi RT10 (4X)

Flaminia	Sprint sospeso	Pozzi Ginori	Quinta	Tenax-Simi	Alba
Pozzi Ginori	Easy / Easy 2	Pozzi Ginori	Citterio		

CW71 PRIMA

Termoindurente - Duroplast

VERSO



cod. 2FSE162602

H050 | Y = da 41,6 a 46,9  
Z = da 9,5 a 19,3



cod. 2FSE175302

H323 | Y = da 42,1 a 47,8  
Z = da 8,6 a 18,7



Azzurra	Class 05	Globo	Prima	Nero Ceramica	Iceberg
Falerii	Mascalzone	Incea	Iside	Vulcano	Iceberg



**Termoindurente - Duroplast  
 PASSEPARTOUT**



cod. 2FSE166402

H050 | Y = da 40,9 a 46,3  
 Z = da 9,3 a 19,4



cod. 2FSE175502

H323 | Y = da 41,6 a 46,3  
 Z = da 8,7 a 18,8



Globo

Grace

**CW84 GOLF**

**Poliestere- Polyester "Sanilux"**

**P84 GOLF**

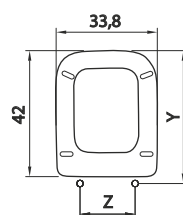

cod. 2FSE148402

UNI NS | Y = da 39,5 a 44  
 Z = da 12,5 a 21,5



Fissaggio con tirante e galletto  
*Fixing with screw and nut*

Paracolpi RT10 (x4)

Azzurra

Minerva

Delta

Golf

**Termoindurente - Duroplast**  
**SMALL**



**cod. 2FSE016502**

H050 | Y = da 37,8 a 43,1 |  
 Z = da 9,4 a 19,5



**Poliestere- Polyester "Sanilux"**  
**P87 - F CONCEPT**

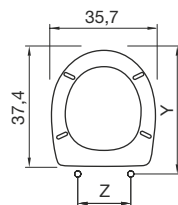

**cod. 2FSE148702**

UNI NS | Y = da 35,2 a 41,8  
 EXP. L. | Z = da 9,5 a 18,5



**Fissaggio con espansore**  
*Fixing with expansion*

**Paracolpi RT10 (x4)**

Falerii

F-Concept

**Termoindurente - Duroplast**

**DOUBLE**



**Cod. 2FSE192402**

NYLON | Z = 16



**Cod. 2FSE183702**

METALLO | Z = 16



**CW201 DUCCIO**

Cesabo	Prestige	Hidra	Montreal	Vitruvit-Profilii	Pella
Etruria	Etruria	Scic	Maxi Iusso		
Gravena	Conny	Senesi	Duccio		

**Poliestere- Polyester "Sanilux"**

**P203 - MONTEBIANCO**

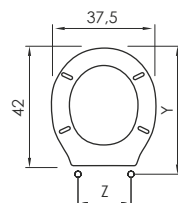

**cod. 2FSE120302**

**UNI NS** | Y= da 39,5 a 44  
 Z= da 9,5 a 18,5



**Fissaggio con tirante e galletto**  
**Fixing with screw and nut**

**Paracolpi RT10 (x4)**

Archiade	Novecento	Gsgi	Melania	Senesi	Palladio
Azzurra	Victorian Stile	Ideal Standard	Moderno	Simas	Esalatore
Cesabo	Gerico	Ideal Standard	Terso	Simas	Londra
Devon & Devon	Etoile	Kerasan	Bellini	Simas	Ottocento
Eos	Arkea	Pozzi Ginori	Montebianco	Vavid	Nike
Eos	Falisca	Sbordoni	Neoclassica	Villeroy & Boch	Firenze
Galassia	Dalt	Sbordoni	Palladio	Vitruvit	Albano
Globo	Paestum	Scala	Sle 2143	Vitruvit	Victoria
Gravena	Imperial	Senesi	Lutezia		

## CW206 OLD ANTEA

**Poliestere- Polyester "Sanilux"**

**P206 - OLD ANTEA**

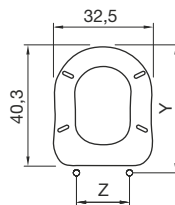

**cod. 2FSE120602**

**UNI NS** | Y = da 38 a 42,5 |  
 Z = da 10,5 a 19,5



**Fissaggio con tirante e galletto**  
**Fixing with screw and nut**

**Paracolpi RT10 (4X)**

Delta

Taormina

Esedra

My Fair

GSI

Antea

## CW211 NEVE

**Termoindurente - Duroplast**

**PASSEPARTOUT**



**cod. 2FSE166402**

**H050** | Y = da 40,9 a 46,3 |  
 Z = da 9,3 a 19,4

**cod. 2FSE175502**

**H323** | Y = da 41,6 a 46,3 |  
 Z = da 8,7 a 18,8



Catalano

Neve

Delta

Futura

Sanitosco

004Open01

Catalano

New Neve

Eos-Simca

Orion

Scic

Kappa

Cesame

Tifeo MB

Gravena

Croma

Simas

Arcade

Cierre Sanitari

Okay 2

Tenax-Simi

Gabbiano

## CW212 TISSI

### Termoindurente - Duroplast PASSEPARTOUT



cod. 2FSE166402

H050 | Y = da 40,9 a 46,3  
 Z = da 9,3 a 19,4



cod. 2FSE175502

H323 | Y = da 41,6 a 46,3  
 Z = da 8,7 a 18,8



Catalano

Tissi

Vitruvit - Profili

Alba

## CW215 MISTRAL

### Termoindurente - Duroplast MITHO



cod. 2FSE002402

H057 | Y = da 43,3 a 47,0  
 Z = da 13,4 a 17,9



### Legno e legno Mdf Wood & Mdf

#### LIUTO

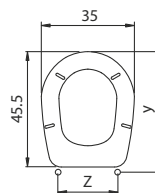

cod. 2FSE188002F1



Y = da 43,5 a 49  
 Z = da 11 a 21

Eos-Simca

Mistral

**Poliestere- Polyester "Sanilux"**

**P216 - SELECTA**

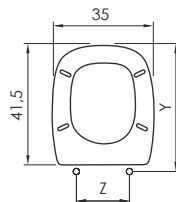

cod. 2FSE121602

UNI NS | Y= da 39,5 a 43,5  
 Z= da 10,5 a 19,5



Fissaggio con tirante e galletto  
 Fixing with screw and nut

Paracolpi Sagoma B (4X)

Hatria-Spea

Selecta

**CW221 STILE**

**Termoindurente - Duroplast**

**MAMBO**



cod. 2FSE009202

H050 | Y = da 42,2 a 47,7  
 Z = da 9,5 a 19,5



cod. 2FSE017502

H323 | Y = da 41,7 a 47  
 Z = da 9 a 19



Galassia

Krio

Pozzi Ginori

Stile

Pozzi Ginori

Stilnova

## CW223 PETRA

Termoindurente - Duroplast

**TERRA**



cod. 2FSE001602

H050 | Y = da 42,5 a 47,7  
 Z = da 11,7 a 22,2

cod. 2FSE001002

H323 | Y = da 42,7 a 47,2  
 Z = da 11,2 a 21,2



Poliestere- Polyester "Sanilux"

**P223 - PETRA**

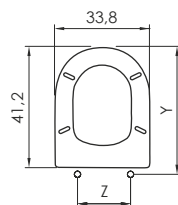

cod. 2FSE122302

UNI NS | Y = da 39 a 43  
 EXP. L. | Z = da 12,5 a 21,5



Fissaggio con espansore  
 Fixing with expansion

Paracolpi RT10 (4X)

Dolomite  
 Eos-Simca

Petra  
 Punto sospesa

Rak  
 Roca

Resort  
 Meridian

## CW226 VISA

Termoindurente - Duroplast

**LUNA 2**



cod. 2FSE202802

H057 | Y = da 42,8 a 47,2  
 Z = da 16,0 a 20,2

cod. 2FSE000802

H323 | Y = da 42,3 a 47,3  
 Z = da 11,1 a 21,1



Legno e legno Mdf  
 Wood & Mdf

**SINTESI**

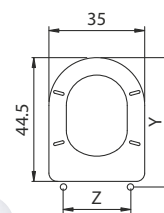

cod. 2FSE189102F1



Y = da 43,5 a 49  
 Z = da 11 a 21

Catalano

Visa

Delta

Navona

Jumbo

Reiroire

**Termoindurente - Duroplast**

**VERSO**



cod. 2FSE162602

H050 | Y = da 41,6 a 46,9  
 Z = da 9,5 a 19,3



cod. 2FSE175302

H323 | Y = da 42,1 a 47,8  
 Z = da 8,6 a 18,7



**CW229 - BRENTA**

**Legno e legno Mdf  
 Wood & Mdf**

**YBO'**

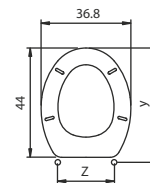

cod. 2FSE182002F1



Y = da 42,5 a 47,5  
 Z = da 11,0 a 21,0

**START**

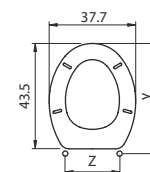

cod. 2FSE187002F1



Y = da 41,5 a 46,5  
 Z = da 10,5 a 20,5

**SITO**

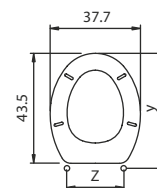

cod. 2FSE198802F1



Y = da 41,5 a 46,5  
 Z = da 10,5 a 20,5



Cesame G.S.I.	Trieste Brenta	Falerii Pozzi Ginori	Novella MB Ipsilon	Scic	Maxi stile
------------------	-------------------	-------------------------	-----------------------	------	------------



## CW230 SELNOVA 3

Legno e legno Mdf  
Wood & Mdf

Termoindurente - Duroplast

### PASSEPARTOUT



cod. 2FSE166402

H050 | Y = da 40,9 a 46,3  
Z = da 9,3 a 19,4

cod. 2FSE175502

H323 | Y = da 41,6 a 46,3  
Z = da 8,7 a 18,8



Poliestere- Polyester "Sanilux"

### P230 - SELNOVA 3

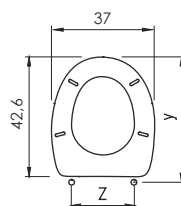

cod. 2FSE123002

UNI NS | Y = da 40 a 44,5  
Z = da 12,5 a 21,5



Fissaggio con tirante e galletto  
Fixing with screw and nut

Paracolpi RT10 (4X)

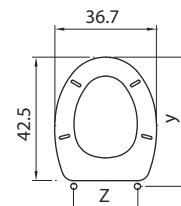

cod. 2FSE204202F1

Y = da 41,5 a 46,5  
Z = da 11 a 21



Althea (Sanitalia)	900	Dolomite	Garda	Olympia	Aurelia
Althea (Sanitalia)	Fly	Dolomite	Garda sospeso	Olympia	Merkur
Amerina	Old Italy	Esedra	Ese	Pozzi Ginori	Pratika
Azzurra	Deca	Flaminia	Web	Pozzi Ginori	Selnova 3
Azzurra	Dodeca	G.S.I.	Clizia	Sbordoni	Fulvia
Azzurra	Elios Sosp.	G.S.I.	Oceano nuovo	Scic	Maxi Aurea
Delta	Gioia	G.S.I.	Tecla	Simas	Luna
Dolomite	Cadore	Hatria-Spea	Onda	Vulcano	Yesterday
Dolomite	Corallo sospesa	Laufen	Swing		

## CW232 BOHEME

Poliestere- Polyester "Sanilux"

### P232 - BOHEME

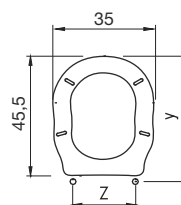

cod. 2FSE123202

UNI NS | Y = da 43 a 47,5  
Z = da 12,5 a 21,5



Fissaggio con tirante e galletto  
Fixing with screw and nut

Paracolpi RT10 (4x)

Althea (Sanitalia)	Royal
Eos-Simca	Boheme/Pantheon
Esedra	Mayfair
Hidra	Ellade

Termoindurente - Duroplast

PASSEPARTOUT



cod. 2FSE166402

H050 | Y = da 40,9 a 46,3  
Z = da 9,3 a 19,4



cod. 2FSE175502

H323 | Y = da 41,6 a 46,3  
Z = da 8,7 a 18,8



Eos - Simca

Punto Sospesa

CW244 LAGO

Poliestere- Polyester "Sanilux"

P244 - LAGO

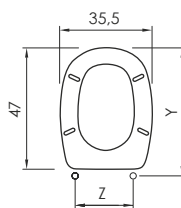

cod. 2FSE124402

UNI NS | Y = da 44,8 a 49,2  
Z = da 12,5 a 21,5



Fissaggio con tirante e galletto  
Fixing with screw and nut

Paracolpi RT10 (4x)

Dolomite

Lago MB

## CW251 SUBWAY

### TERRA



cod. 2FSE001602

H050 | Y = da 42,5 a 47,7  
 Z = da 11,7 a 22,2

cod. 2FSE001002

H323 | Y = da 42,7 a 47,2  
 Z = da 11,2 a 21,2



Villeroy & Boch

Subway

## CW253 YDRA

Termoindurente - Duroplast

### LUNA 2



cod. 2FSE000502

H050 | Y = da 42,5 a 47,7  
 Z = da 11,7 a 22,2

cod. 2FSE000802

H323 | Y = da 42,3 a 47,3  
 Z = da 11,1 a 21,1



Poliestere- Polyester "Sanilux"

### P253 - YDRA

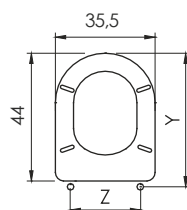

cod. 2FSE125302

UNI NS | Y = da 41,5 a 46,5  
 Z = da 12,5 a 21,5



Fissaggio con tirante e galletto  
 Fixing with screw and nut

Paracolpi anteriori SAGOMA A (2X)  
 Paracolpi posteriori TD10 (2X)

Legno e legno Mdf  
 Wood & Mdf

Adatto a ESEDRA

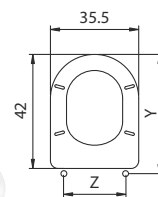

cod. 2FSE190102F1

Y = da 41,5 a 44,0  
 Z = da 13,5 a 17,5



Pozzi Ginori

Ydra

## Termoindurente - Duroplast

### LUNA 2



cod. 2FSE202802

H057 | Y = da 42,8 a 47,2  
Z = da 16,0 a 20,2

cod. 2FSE000802

H323 | Y = da 42,3 a 47,3  
Z = da 11,1 a 21,1



### ARIA



cod. 2FSE205102

H057 | Y = da 43 a 46,5  
Z = da 13,4 a 17,8

cod. 2FSE200302

H323 | Y = da 41,7 a 46,2  
Z = da 11,5 a 21,5



## Poliestere- Polyester "Sanilux"

### P254 - CANOVA

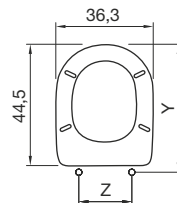

cod. 2FSE125402

UNI NS | Y = da 43 a 47,5  
Z = da 12,5 a 21,5



Fissaggio con tirante e galletto  
Fixing with screw and nut

Paracolpi RT10 (4X)

## Legno e legno Mdf Wood & Mdf

### SINTESI

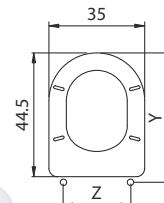

cod. 2FSE189102F1

Y = da 43,5 a 49  
Z = da 11 a 21



Catalano	Canova	Olympia	Federica
Cesame	Sintesi sospesa	Olympia	Rubino 1
Cierre Sanitari	Dea	Olympia	Rubino 2
Delta	Gea	Olympia	Serie 92
Dolomite	RC 80	Olympia	Serie 92 Sospesa
Duravit	Dellarco	Olympia	Vaso c/ esalatore
Duravit	Vienna	Olympia	Vela
Eos-Simca	Antaga	Olympia	Vela 2
Falerii	Chiara	Olympia	Vogue
Flaminia	Link-Mini Link	Pozzi Ginori	Atena
G.S.I.	Avant	Roca	Tipo
G.S.I.	Dafne	Tenax-Simi	Geo
G.S.I.	Desy	Vavid	Orientale
G.S.I.	Giulia	Vavid	Tebe
Globo	Misura 1	Villeroy & Boch	Alpina
Hatria-Spea	Marilyn	Villeroy & Boch	Magnum
Incea	Sara		
Kerasan	Montego		

Termoindurente - Duroplast

MAMBO



cod. 2FSE167702

H057 | Y = da 43,3 a 47,4  
 Z = da 13,1 a 17,5

cod. 2FSE017502

H323 | Y = da 41,7 a 47  
 Z = da 9 a 19



Ceramica Cielo Lara  
 Globo Lei

CW256 LEI

Legno e legno Mdf  
 Wood & Mdf

YBO'

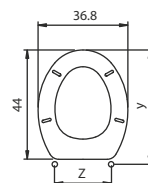

cod. 2FSE182002F1



Y = da 42,5 a 47,5  
 Z = da 11,0 a 21,0

SITO

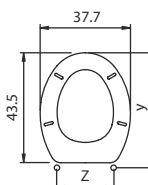

cod. 2FSE198802F1



Y = da 41,5 a 46,5  
 Z = da 10,5 a 20,5



CW262 FLEO

Legno e legno Mdf  
 Wood & Mdf

FLEO

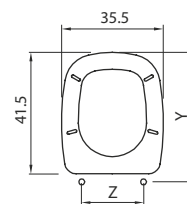

Cod. 2FSE201202F1



Y = da 40 a 45  
 Z = da 11 a 21

Poliestere- Polyester "Sanilux"

P262 - FLEO

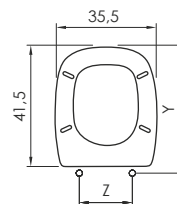

cod. 2FSE126202

UNI NS | Y = da 39,5 a 43,5  
 Z = da 10,5 a 19,5



Fissaggio con tirante e galletto  
 Fixing with screw and nut

Paracolpi RT10 (4X)

Dolomite Fleo

**Termoindurente - Duroplast**

**MAMBO**



cod. 2FSE009202

H050 | Y = da 42,2 a 47,7 |  
 Z = da 9,5 a 19,5



**Poliestere- Polyester "Sanilux"**

**264 - ALA**

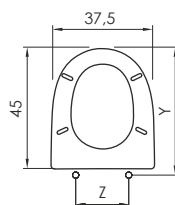

cod. 2FSE126459

UNI NS | Y= da 42,5 a 47  
 Z= da 12,5 a 21,5



**Fissaggio con tirante e galletto**  
**Fixing with screw and nut**

**Paracolpi RT10 (4X)**

Cierre Sanitari  
 G.S.I.

Terminillo  
 Farenheit

Ideal Standard  
 Pozzi Ginori

Ala-Ala Sospeso  
 Baia

**CW277 FULL 56**

**Termoindurente - Duroplast**

**MAMBO**



cod. 2FSE167702

H057 | Y = da 43,3 a 47,4 |  
 Z = da 13,1 a 17,5



Azzurra

Full 56

Termoindurente - Duroplast

VERSO



cod. 2FSE162602

H050 | Y = da 41,6 a 46,9  
 Z = da 9,5 a 19,3

cod. 2FSE175302

H323 | Y = da 42,1 a 47,8  
 Z = da 8,6 a 18,7



Hidra	Loft
Opera Sanitari	Oxa
Pendy	Gravena

CW278 LOFT

Legno e legno Mdf  
 Wood & Mdf

YBO'

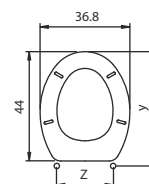

cod. 2FSE182002F1



Y = da 42,5 a 47,5  
 Z = da 11,0 a 21,0

SITO

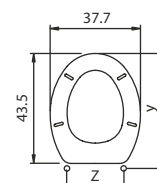

cod. 2FSE198802F1



Y = da 41,5 a 46,5  
 Z = da 10,5 a 20,5



CW279 SMARTY

Termoindurente - Duroplast

SMALL



cod. 2FSE016502

H050 | Y = da 37,8 a 43,1  
 Z = da 9,4 a 19,5



Axa	Rond	Hidra	Smarty
-----	------	-------	--------

Termoindurente - Duroplast

SAMBA



2FSE158602 (SAMBA)

H057 | Y = da 42,4 a 45,7 |  
 Z = da 14,1 a 18,7 |



Incea

Nube

CW283 FIDIA

Termoindurente - Duroplast

LUNA 2



cod. 2FSE202802

H057 | Y = da 42,8 a 47,2 |  
 Z = da 16,0 a 20,2 |

cod. 2FSE000802

H323 | Y = da 42,3 a 47,3 |  
 Z = da 11,1 a 21,1 |



Poliestere- Polyester "Sanilux"

P283 - FIDIA

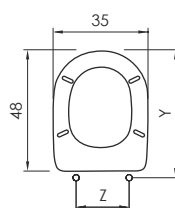

cod. 2FSE128302

UNI NS | Y = da 45,7 a 50,2 |  
 Z = da 12,5 a 21,5 |



Fissaggio con tirante e galletto  
 Fixing with screw and nut

Paracolpi RT10 (4X)

Legno e legno Mdf  
 Wood & Mdf

SINTESI

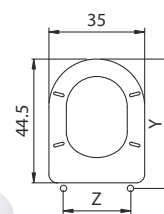

cod. 2FSE189102F1

| Y = da 43,5 a 49 |  
 Z = da 11 a 21 |



Flaminia

Fidia

Flaminia

Fidia vecchio

Galassia

Aster



**Termoindurente - Duroplast**

**VERSO**



cod. 2FSE166302

H057 | Y = da 42,3 a 46  
 Z = da 13,3 a 17,8

cod. 2FSE175302

H323 | Y = da 42,1 a 47,8  
 Z = da 8,6 a 18,7



Dolomite	Perla New	Incea	Jo
Hatria-Spea	Cannes Sospeso	Incea	Opi
Hatria-Spea	Erika Sospeso	Tenax-Simi	Pegaso
		Villeroy & Boch	Pegaso

**CW286 PERLA**

Legno e legno Mdf  
 Wood & Mdf

**YBO'**

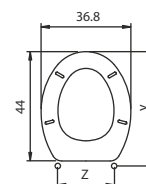

cod. 2FSE182002F1



Y = da 42,5 a 47,5  
 Z = da 11,0 a 21,0

**SITO**

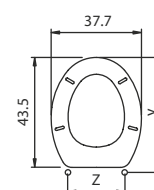

cod. 2FSE198802F1



Y = da 41,5 a 46,5  
 Z = da 10,5 a 20,5



**Termoindurente - Duroplast**

**LUNA 2**



cod. 2FSE000502

H050 | Y = da 42,5 a 47,7  
 Z = da 11,7 a 22,2

cod. 2FSE000802

H323 | Y = da 42,3 a 47,3  
 Z = da 11,1 a 21,1



**CW287 PLUVIA SOSPESO**

Hidra

Pluvia sospeso

## Termoindurente - Duroplast

### DYNASTY



cod. 2FSE192202

H050 | Y = da 40,0 a 45,0  
 Z = da 11,0 a 21,0



Globo

Divia

Galassia

Eden

# CW300 SMART

## Termoindurente - Duroplast

### VERSO



cod. 2FSE166302

H057 | Y = da 42,3 a 46,0  
 Z = da 13,3 a 17,8



cod. 2FSE175302

H323 | Y = da 42,1 a 47,8  
 Z = da 8,6 a 18,7



Delta

Smart

Falerii

Victoria

Galassia

Princes

## CW572 VENICE

Termoindurente - Duroplast

VERSO



cod. 2FSE162602

H050 | Y = da 41,6 a 46,9  
 Z = da 9,5 a 19,3

cod. 2FSE175302

H323 | Y = da 42,1 a 47,8  
 Z = da 8,6 a 18,7



Rak

Venice

Simas

LFT Spazio

## CW573 PLUVIA

Termoindurente - Duroplast

LUNA 2



cod. 2FSE202802

H057 | Y = da 42,8 a 47,2  
 Z = da 16,0 a 20,2

cod. 2FSE000802

H323 | Y = da 42,3 a 47,3  
 Z = da 11,1 a 21,1



Hidra

Pluvia

Ceramica Cielo

Florence

Legno e legno Mdf  
 Wood & Mdf

SINTESI

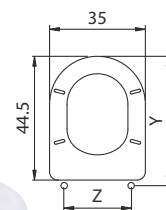

cod. 2FSE189102F1



Y = da 43,5 a 49  
 Z = da 11 a 21

**Termoindurente - Duroplast**

**PASSEPARTOUT**



cod. 2FSE164602

H057 | Y = da 41,8 a 45,7  
 Z = da 13,3 a 17,8



**Poliestere- Polyester "Sanilux"**

**P575 - ANGELA**

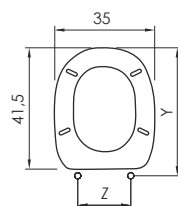

cod. 2FSE157502

UNI NS | Y = da 39,5 a 43,5  
 Z = da 12,5 a 21,5



Fissaggio con tirante e galletto  
 Fixing with screw and nut

Paracolpi SAGOMA A (4X)

Hidra

Angela

**CW579 OBJECT**

**Termoindurente - Duroplast**

**TERRA**



cod. 2FSE001602

H050 | Y = da 42,5 a 47,7  
 Z = da 11,7 a 22,2



cod. 2FSE001002

H323 | Y = da 42,7 a 47,2  
 Z = da 11,2 a 21,2



**Termoindurente - Duroplast**

**ARIA**



cod. 2FSE203102

H050 | Y = da 41,5 a 46,7  
 Z = da 12,0 a 22,5



cod. 2FSE200302

H323 | Y = da 41,7 a 46,2  
 Z = da 11,5 a 21,5



Laufen

Object

Hatria-Spea

Dolce Vita

**Termoindurente - Duroplast**

**SEBINO**



**2FSE005902**

**H011** | Y = da 42,7 a 45,0 |  
 Z = da 13 a 17,9



**2FSE015902**

**H057** | Y = da 42,4 a 45,7 |  
 Z = da 14,1 a 18,7



**CW583 COLIBRI' 2**

**Legno e legno Mdf  
 Wood & Mdf**

**COLIBRI'**

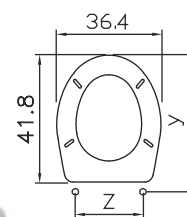

**cod. 2FSE196602F1**



Y = da 40 a 45  
 Z = da 10 a 20

Pozzi Ginori	Cervino	Roca	Victoria
Pozzi Ginori	Colibrì 2	Scala	Gemma
Pozzi Ginori	Kim		

**CW584 TONDA**

**Termoindurente - Duroplast**

**DYNASTY**



**cod. 2FSE192202**

**H050** | Y = da 40,0 a 45,0 |  
 Z = da 11,0 a 21,0



Globo	New Arianna	Ideal Standard	Tonda	Scala	Meridiana
-------	-------------	----------------	-------	-------	-----------

## CW586 PANCARE/ CARENA

**Termoindurente - Duroplast**  
**PANCARE/CARENA**



**Cod. 2FSE197102**

**PANCARE** | N.D.

Ceramiche Cidneo

Pancare - Carena



**GAMMA SEDILI WC PER DISABILI CON E SENZA COPERCHIO  
DISABLES WC SEATS WITH AND WITHOUT COVER**

**Termoindurente - Duroplast**

**HELP**

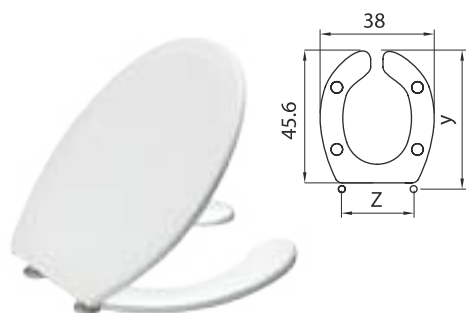

Cod. 2FSE204302

HELP | Y = da 42,8 a 47,8  
 Z = da 12,5 a 17,5



Fissaggio con tirante e dato  
 Fixing with screw and nut

Paracolpi tondi HELP (4X)

**Termoindurente - Duroplast**

**HELP - solo ANELLO**

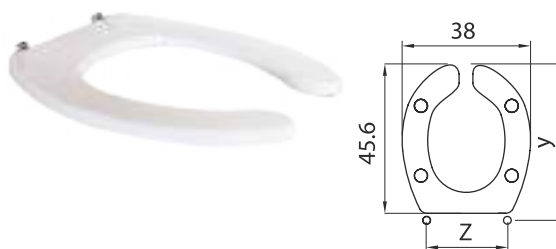

Cod. 2FSE204402

HELP | Y = da 42,8 a 47,8  
 Z = da 12,5 a 17,5

Fissaggio con tirante e dato  
 Fixing with screw and nut

Paracolpi tondi HELP (4X)



**CW522 - ANELLO 10 cm**

**Poliestere- Polyester "Sanilux"**

**P522 - ANELLO universale rialzato 10 cm**  
*Universal raised ring 10 cm*



cod. 4FDI522502

REGOLABILE | Y = da 40,5 a 43  
 Z = da 4 a 15,5

Fissaggio con tirante e galletto  
 Fixing with screw and nut

Paracolpi RT10 (4x)

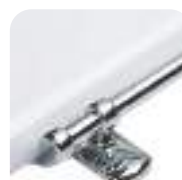





**ADATTABILITÀ SEDILI WC PER CASA CERAMICA**  
**WC SEATS ADAPTABILITY BY CERAMIC MANUFACTURES**

## Alice Ceramica

Form	CW21
------	------

## Althea (Sanitalia)

900	CW230	Fly	CW230	Ring	CW12
Althea	CW12	Marea	CW12	Rose	CW17
Cento	CW01	Marion	CW12	Royal	CW232
Cora	CW17	Melrose	CW12	Sky	CW06
Cover	CW21	Hola	CW01		
Elena	CW14	Plaza	CW17		

## Amerina

Arco	CW12	Armony	CW12	Old Italy	CW230
------	------	--------	------	-----------	-------

## Archiade

Fausta	CW01	Marina	CW12	Ottocento	CW203
Flaminia	CW01	Neoclassica	CW203	Palladio	CW203
Fulvia	CW01	Novecento	CW203	Sospesa	CW21

## Artigianato Ceramico/Vitrodurex

Boxer	CW19	Ghibli	CW01	Rex	CW02
Croma	CW12	Oasi	CW01	Safari	CW06
Duna	CW01				

## Astra

Divina	CW12	Impero MB	CW01	Serie 83	CW26
Gemma	CW26	Lido	CW06	Serie 84	CW12
Hi-fi	CW26	Mia	CW26	Serie 85	CW12
Impero	CW06	Olimpia	CW01	Trio	CW06

## Axa

Axa2	CW26	Mirto	CW01	Scilla	CW12
Clivia	CW12	Rond	CW279	Verbena	CW12

## Azzurra

Adone	CW19	Elena	CW26	Le Onde	CW17
Afrodite	CW17	Elios	CW26	Midas	CW17
Alba	CW01	Elios Sosp.	CW230	Minerva	CW84
Aris	CW06	Frine	CW12	Novecento	CW26
Class 05	CW71	Full 56	CW277	Nuvola	CW21

Continua a pagina seguente →

Comoda	CW16	Giove	CW01	Ottocento	CW26
Deca	CW230	Giulia MB	CW26	Paola	CW12
Diana	CW26	I Meridiani	CW19	Venere	CW12
Divina	CW12	I Sensi	CW12	Vera	CW203
Dodeca	CW230	Iris	CW19		

### Catalano

Aria nuovo	CW14	Neve	CW211	Tissi	CW212
Canova	CW254	New Neve	CW211	Visa	CW226
Free	CW21	Odeon	CW12	Zero light 50	CW584
Junior	CW06	Sphera vecchio	CW21		
Luce	CW01	Taormina	CW30		

### Ceramica Cielo

Ares	CW12	Ermes	CW01	Mithos	CW203
Celia	CW12	Florence	CW573	Smile	CW21
Enjoy	CW16	Lara	CW256	Sveda	CW02

### Cesabo

Alexandra	CW01	Elite	CW01	Prestige	CW201
Alessandro classic	CW01	Endurance	CW12		

### Cesame

900	CW49	Dorica	CW06	Sintesi sospesa	CW254
Aretusa	CW13	Equa	CW264	System	CW12
Aretusa Sospesa	CW14	Sila	CW06	Taormina	CW06
Aretusina	CW14	Simplex	CW01	Tifeo MB	CW211
Aretusina MB	CW14	Sintesi	CW11	Trieste	CW229
Belle Epoque	CW32	Sintesi MB	CW12		

### Cidneo

Pancare/Carena	CW586				
----------------	-------	--	--	--	--

### Cierre Sanitari

Cortina	CW02	Okay 2	CW211	Super	CW17
Dea	CW254	Okay 2 sospesa	CW12	Terminillo	CW264
Desirée	CW26	Ortisei	CW01		
Leonessa	CW06	Piuma	CW26		

## Cifial

Eden	CW05		
------	------	--	--

## Delta

Caravaggio	CW06	Golf	CW84	Sahara	CW12
Delta	CW06	Michelangelo MB	CW06	Samba	CW06
Futura	CW211	Navona	CW226	Smart	CW300
Gea	CW254	Oceano New	CW01	Solara	CW12
Gioia	CW230	Raffaello	CW01	Trevi	CW203

## Disegno Ceramica

Basik	CW203	Giulia	CW32	Skip	CW21
-------	-------	--------	------	------	------

## Dolomite

Alpina	CW16	Cristallo	CW30	Petra	CW223
Cadore	CW230	Donatello	CW06	Quadrarco	CW16
Charlotte	CW203	Fleo	CW262	Q3	CW15
Clodia	CW10	Garda / Garda sosp.	CW230	Quarzo	CW30
Clodia MB	CW10	Lago	CW244	RC 80	CW254
Corallo	CW28	Perla Classic	CW06	Rio	CW15
Corallo sospesa	CW230	Perla New	CW286		

## Duravit

Architec	CW01	D-Code	CW19	Nube	CW26
Darling	CW01	Erica	CW21	Speciale	CW01
Dellarco	CW254	Laconda	CW01	Vienna	CW254
Duraplus	CW01				

## Eos-Simca

Antaga	CW254	Falisca	CW203	Orion	CW211
Arkea	CW229	Flower	CW17	Primula	CW06
Armonia	CW17	Jolly	CW01	Punto	CW03
Astro	CW26	Medea	CW30	Punto sospesa	CW233
Boheme/Pantheon	CW232	Mistral	CW215	Riace-Segesta	CW03
Cimino	CW01	Ola	CW26	Stylon	CW06
Clio	CW14	Orchidea	CW01	Tulipano	CW01

## Esedra

Ese	CW230	Ever	CW21	Mayfair	CW232
-----	-------	------	------	---------	-------

## Etruria

Alba	CW17	Arista	CW06	Etruria	CW201
Apollo	CW19	Conchiglia	CW06	Sirio	CW01

## Euroceramiche (Mithos-Micas)

Gioia	CW02	Novecento	CW203	Più	CW06
Iris	CW01	Ottocento	CW203	Valentina	CW12

## Falerii

Adria	CW17	H2O	CW16	Vaso 2 fori	CW203
Aida	CW17	Medina	CW02	Victoria	CW300
Chiara	CW254	Mascalzone	CW71	Tiffany	CW12
F-concept	CW87	Novella	CW01	Thermae	CW30
Gaia	CW01	Novella MB	CW229		
Giulietta	CW17	Sabrina	CW01		

## Flaminia

App	CW44	Metro	CW17	Relax sospesa	CW12
Arena	CW01	Metro Sospesa	CW14	Sprint sospeso	CW60
Fidia	CW283	Nori	CW06	Valentine Nuovo	CW12
Fidia Vecchio	CW283	Pompei	CW01	Void	CW21
Isabel	CW26	Quick	CW44	Web	CW230
Link / Mini Link	CW254	Relax	CW12		

## Galassia

Ala	CW06	Ethos	CW203	Piuma	CW14
Aster	CW283	Krio	CW221	Princes	CW300
Eden	CW291	Olà	CW01	Vera	CW01

## Galvit

Agorà	CW14	Dalì	CW203	Miro'	CW32
Casmona	CW203	Egira	CW06		

## Globo

Alia	CW12	Flavia (Alia)	CW26	Open Space <small>Concept</small>	CW21
Arianna	CW01	Grace	CW26	Open Space sos.	CW17
Arianna MB	CW06	Impero	CW203	Paestum	CW203
Arianna New	CW584	Grace Filo parete	CW81	Pascha	CW09
Bonsai Sospeso	CW203	Lei	CW256	Prima	CW71
Divà	CW291	Lei MB	CW06	Misura 1	CW254

## Gravena

Conny	CW201	Gaia	CW14	Pendy	CW26
Croma	CW211	Garbo	CW12	Rhonda	CW04
Dafne	CW21	Giada	CW14		
Derby	CW01	Jenny	CW01		

## G.S.G.

Alfa	CW01	Atene	CW01	Melania	CW203
Ambra	CW17	Elisa	CW12	Roma	CW01
Astra	CW12	Jasmine	CW12		

## G.S.I. (Facis, Venus)

Antea/Old Antea	CW206	Desy	CW254	Modo	CW01
Avant	CW254	Elisa	CW12	Oceano nuovo	CW230
Blitz	CW12	Essenza	CW28	Pura	CW21
Brenta	CW229	Fahrenheit	CW264	Pitti	CW12
City Pro	CW03	Garda	CW01	Tecla	CW230
Clizia	CW230	Giada	CW01	Time	CW19
Community	CW03	Giulia	CW254	Topazio	CW01
Dafne	CW254	Iseo	CW01	Vela	CW02
Davina	CW32	Lugano	CW01	Xenia 1	CW14

## Hatria-Spea

Amalfi	CW01	Erika	CW06	Marilyn	CW254
Baia	CW06	Erika Sospeso	CW286	Monaco	CW06
Cannes	CW06	Imperia	CW203	Nizza	CW06
Cannes Sospeso	CW286	Lisa	CW07	Onda	CW230
Daytime	CW579	Lotus	CW19	Selecta	CW216
Edilizia	CW06				

## Hidra

Angela	CW575	My	CW81	Pluvia	CW573
Athena	CW06	Montreal	CW201	Record	CW06
Brasilia	CW06	Nautilus Sospesa	CW06	Roma	CW06
Ellade	CW232	Onda	CW26	Smarty	CW279
Loft	CW278	Pegaso	CW26	Top line	CW12
Memory	CW32	Pluvia sospeso	CW287		

## Ideal Standard

Absolute Kurokawa	CW44	Fiorile	CW03	Ponti	CW01
Ala-Ala Sospeso	CW264	Fiorile new	CW21	Terso	CW203
Calla	CW43	Fiorile sospeso	CW21	Tesi	CW05
Classica	CW203	Fiorile Lusso sospeso	CW21	Tonda	CW584
Conca	CW02	Linda / Linda sospeso	CW03	Tonic	CW579
Ellisse	CW06	Liuto	CW04	Wash point	CW21
Ellisse Piu'	CW06	Moderno	CW03	Zanvas (Ponti Zeta)	CW06
Esedra	CW21				

## Ilca

Itaca	CW06	Menfi	CW06	Tebe	CW01
Micene	CW01				

## Incea

Iside	CW71	Opi	CW286	Sara	CW254
Jo	CW286	Supra	CW01	Vesuvio	CW06
Nube	CW281				

## Indusa

Alfa	CW12	Aveiro	CW14		
------	------	--------	------	--	--

## Isvea

Aventino	CW06	Monika	CW32		
C.O.	CW02	Montello	CW09		

## Jumbo

Aretha	CW17	Renoire	CW226	Tema	CW19
Arethona	CW17	Simpaty	CW12	Tua	CW26
Golia	CW06				

## Kerafina

Fryni	CW12	Millenium	CW32	Vergina	CW17
Narkisos	CW12	Lito	CW17		

## Keramag

Koblenz	CW30				
---------	------	--	--	--	--

## Keraskan

Brio	CW216	Elka	CW26	Luna	CW06
------	-------	------	------	------	------

Continua a pagina seguente →

Blu Angel	CW203	Europa	CW06	Montego	CW254
Godia	CW17	Jolly	CW06		

## Laufen

Dino	CW06	Gallery	CW06	Object	CW579
Dino sospesa	CW14	Jika	CW06	Swing	CW230
D-Code	CW19	Lyra	CW30		

## Nero Ceramica

Iceberg	CW71				
---------	------	--	--	--	--

## Olympia

Ambra	CW01	Rio	CW12	Vela	CW254
Aurelia	CW230	Rubino 1	CW254	Vela 2	CW254
Federica	CW254	Rubino 2	CW254	Vogue	CW254
Impero	CW203	Serie 92 - Serie 92 Sosp.	CW254		
Merkur	CW230	Vaso con escalatore	CW254		

## Pozzi Ginori

500	CW27	Gardena	CW01	Piemontesina	CW09
Arcobaleno	CW01	Ginepro	CW01	Pratika	CW230
Atena	CW254	Idea	CW583	Q3	CW15
Aura	CW01	Idro	CW01	Quinta	CW60
Aurora	CW01	Ilgarda	CW30	Selnova	CW01
Baia	CW264	Ipsilon	CW229	Selnova 3 / Pro	CW230
Cervinia	CW01	Ipsinova	CW229	Selva	CW01
Cervino	CW30	Italica	CW18	Sirena	CW229
Colibrì	CW30	Kim	CW30	Square	CW07
Colibrì 2	CW583	Linea	CW03	Stile	CW221
Conchiglia MB	CW229	Mini	CW06	Stilnova	CW221
Curva	CW01	Modulo	CW01	Tabor	CW01
Easy	CW60	Montebianco	CW203	Torcello	CW01
Elios	CW01	Monviso	CW30	Torena	CW06
Europa	CW01	Murano	CW06	Ydra	CW253
Fantasia	CW01	Piemonte	CW09		

## Rak

Compact	CW21	Metropolitan	CW76	Resort	CW223
Karla	CW01	Orient	CW575	Venice	CW572



## Roca

Meridian	CW223	Polo	CW30	Victoria	CW30
Neo Victoria	CW01	Tipo	CW254	Zoom	CW26
Nexo	CW21				

## Sanex

Tania	CW05				
-------	------	--	--	--	--

## Sanindusa - Indusa

Alpha	CW12	Prestige	CW12		
-------	------	----------	------	--	--

## Sanitosco

004 Open01	CW211				
------------	-------	--	--	--	--

## Sbordoni

Fabia	CW04	Fulvia	CW230	Moderno Classica	CW203
Fausta	CW06	Kerafin	CW30	Palladio	CW203
Flaminia	CW01	Marina	CW12	Sospesa	CW26
Flavia	CW30	Neoclassica	CW203		

## Scala

Friuli	CW01	Meridiana	CW584	Sile 2143	CW203
Gemma	CW30	Primavera	CW01	Tanga	CW04
Iril	CW06	Rugiada	CW01	Tau	CW01
Longa	CW01				

## Scic

Bella	CW12	L'altra Linea	CW12	Maxi lusso	CW201
Donna	CW12	Maxi Aurea	CW230	Maxi stile	CW229
Kappa	CW211	Maxi Jolly	CW06		

## Senesi

Balzana	CW06	Leonardo	CW01	Pienza	CW05
Brunello	CW01	Lutezia	CW203	Sovana	CW17
Donatello	CW06	Michelangelo	CW01	Tosca	CW21
Duccio	CW201	Palladio	CW203	Tuscia	CW03
Guelfa	CW06				

## Simas

Alfa	CW01	Europa 2° versione	CW32	Montezuma	CW01
------	------	--------------------	------	-----------	------

Continua a pagina seguente →

Arcade	CW211	Gatteo	CW01	Nafura	CW206
Beta	CW01	LFT Spazio	CW572	Primavera	CW26
Deborah	CW01	Londra	CW203	Selenia	CW26
Eco	CW01	Lory	CW30	Teoria	CW203
Esalatore	CW203	Luna	CW230	Modulo	CW26

## Tenax-Simi

Alba	CW60	Geo	CW254	Vega	CW01
Airone	CW01	Tenax	CW06	Pegaso	CW286
Gabbiano	CW211				

## Vavid

Farnese	CW06	Nike	CW203	Partenopea	CW06
Mistral	CW19	Nordica	CW18	Tebe	CW254

## Villeroy & boch

Alpina	CW254	Pegaso	CW286	Subway	CW251
Magnum	CW254				

## Vincenti

Antica	CW32	Farah	CW26	Uno	CW26
Brava	CW06	Milano	CW01	Versilia	CW02
Curva	CW05	Tipo	CW12		

## Vitra

Architet sosp	CW30	Elena / Normus	CW06	S50	CW16
---------------	------	----------------	------	-----	------

## Vitruvit-Profil

Alba	CW212	Fantasia	CW12	Partenone	CW01
Albano	CW203	Florida MB	CW02	Partenone MB	CW01
Alessandra	CW32	Gronda	CW02	Pella	CW201
Apollo-Vulcano	CW09	Impero	CW203	Roma	CW06
Armonia	CW21	Lady	CW01	Sky3	CW01
Calipso	CW01	Maiorca	CW32	Sprint	CW01
Diana	CW30	Minerva	CW01	Stella	CW12

## Vulcano

Classic	CW21	Primavera	CW32	Yesterday	CW230
Iceberg	CW71				



**RICAMBI PER TUTTA LA GAMMA SEDILI WC**  
**SPARE PARTS FOR WC SEATS**



## H010

Kit cerniere per modelli wc/Hinges kit for wc models:  
Iseo

Cod. 2FSE501002

Nylon  
Nylon



## H011

Kit cerniere per modelli wc/Hinges kit for wc models:  
Anatomico, Aqua, Bernina, Bimbo, Cervino, Chamonix, Felice,  
Giglio, Loto, Mambo, Mare, Melora, Mitho, Passepartout, Rodeo,  
Samba, Sebino, Sestriere, Small, Tango, Terra, Tesi, Venezia, Z0, Z1

Cod. 2FSE501102

Nylon  
Nylon



## H012

Kit cerniere per modelli wc/Hinges kit for wc models:  
Riva, Z2, Z10, Z10S

Cod. 2FSE501202

Nylon  
Nylon



## H013

Kit cerniere per modelli wc/Hinges kit for wc models:  
Panchetta

Cod. 2FSE501302

Nylon  
Nylon



## H016

Cod. 2FSE501602

Nylon  
Nylon



Imballo multiplo per tutti i ricambi cerniere in sacchetto: 12 pz  
Multiple box for all spare parts hinges in polybag: 12 pcs



## H019

Cod. 2FSE501902

Nylon  
Nylon



## DOUBLE

Kit cerniere per modelli wc/Hinges kit for WC models:  
Double

Cod. 2FSE546402

Nylon  
Nylon



## H025

Cod. 2FSE502560

Inox  
Stainless  
steel



## H050

Cod. 2FSE505060

Inox  
Stainless  
steel



## H057

Cod. 2FSE515760

Inox  
Stainless  
steel



Imballo multiplo per tutti i ricambi cerniere in sacchetto: 12 pz  
Multiple box for all spare parts hinges in polybag: 12 pcs



## H306

Cod. 2FSE536002

Nylon  
Nylon



## H481

Cod. 2FSE551260

Nylon  
Nylon



## H482

Cod. 2FSE548460

Nylon  
Nylon



## H323

Cod. 2FSE543260

Metallo  
cromato  
Chromed  
metal



Imballo multiplo per tutti i ricambi cerniere in sacchetto: 12 pz  
Multiple box for all spare parts hinges in polybag: 12 pcs



Chiave universale per sedili wc/Universal key for wc seats

Cod. 2FSE500000

Imballo multiplo in sacchetto: 12 pz  
Multiple box in polybag: 12 pcs

Cod. 2FSE500001

Imballo multiplo con pezzi sfusi: 100 pz  
Multiple box with no pack: 100 pcs

Paracolpi di ricambio per sedili wc in termoindurente e termoplastico  
*Spare part buffers for Duroplast and thermoplastic toilet seats*



Kit paracolpi per modelli wc/*Buffers kit for wc models:*  
Anatomico, Bernina, Bimbo, Evolution, Felice, Giglio,  
Loto, Luna, Luna 2, Mambo, Mare, Mitho, Onda, Pan-  
chetta, Riva, Small, Tango, Terra, Venezia, Z10, Z10 S

**Cod. 2FSE500302**

---



Kit paracolpi per modelli wc/*Buffers kit for wc models:*  
Aqua, Passepartout, Rodeo, Verso

**Cod. 2FSE511402**

---



Kit paracolpi per modelli wc/*Buffers kit for wc models:*  
Chamonix, Iseo, Samba, Sestriere, Sebino, Z0, Z1, Z2

**Cod. 2FSE500202**

---



Kit paracolpi per modelli wc/*Buffers kit for wc models:*  
Cervino

**Cod. 2FSE500402**

---



Kit paracolpi per modelli wc/*Buffers kit for wc models:*  
Ap, Reverse

**Cod. 2FSE548802**

Paracolpi di ricambio per sedili wc in termoindurente e termoplastico  
*Spare part buffers for Duroplast and thermoplastic toilet seats*



Kit paracolpi per modelli wc/*Buffers kit for wc models:*  
Double, Speed

**Cod. 2FSE546502**

---



Kit paracolpi per modelli wc/*Buffers kit for wc models:*  
Valencia, Match

**Cod. 2FSE539302**

---



Kit paracolpi per modelli wc/*Buffers kit for wc models:*  
Five

**Cod. 2FSE524802**

---



Kit paracolpi per modelli wc/*Buffers kit for wc models:*  
Help - solo anello

**Cod. 2FSE554007**

Imballo multiplo per tutti i ricambi paracolpi in sacchetto: 12 pz  
*Multiple box for all spare parts buffers: 12 pcs*



### UNI



**cod. 2FSE536260**

Metallo, regolabile, fissaggio con tirante, avvitabile dal basso.

*Metal, adjustable, screw and bottom fixing.*

### UNI NS



**cod. 2FSE508060**

Metallo, regolabile, fissaggio con tirante, avvitabile dal basso.

*Metal, adjustable, screw and bottom fixing.*

### CONCA



**cod. 2FSE503660**

Metallo, fissa, fissaggio con tirante, avvitabile dal basso.

*Metal, fix, screw and bottom fixing.*

### EXP. UNI NS



**cod. 2FSE541760**

Metallo, regolabile, fissaggio con espansore, avvitabile dall'alto.

*Metal, adjustable, extension dowl and top fixing.*

### EXP. FISSA



**cod. 2FSE503560**

Metallo, fissa, fissaggio con espansore, avvitabile dall'alto.

*Metal, fix, extension dowl and top fixing.*

### UNI NS INOX



**cod. 2FSE542360**

Acciaio Inox, regolabile, fissaggio con tirante, avvitabile dal basso.

*Stainless Steel, adjustable, screw and bottom fixing.*

Imballo multiplo: 1 pz  
Multiple box: 1 pc

### UNI NS EXP. LAT. INOX



**cod. 2FSE541860**

Acciaio Inox, regolabile, fissaggio con espansore, avvitabile dall'alto.

*Stainless Steel, adjustable, extension dowl and top fixing.*

Imballo multiplo: 1 pz  
Multiple box: 1 pc

### CLODIA



**cod. 2FSE542160**

Acciaio Inox, fissa, fissaggio con espansore, avvitabile dall'alto.

*Stainless Steel, fix, extension dowl and top fixing.*

Imballo multiplo: 1 pz  
Multiple box: 1 pc

## Cerniere di ricambio per sedili wc in poliestere Sanilux Hinges spare parts for polyester toilet seats Sanilux

### EPOCA



**cod. 2FSE542460**

Acciaio Inox, fissa, fissaggio con espansore, avvitabile dall'alto.

*Stainless Steel, fix, extension dowl and top fixing.*

Imballo multiplo: 1 pz  
Multiple box: 1 pc

### AMERICANA



**cod. 2FSE537760**

Acciaio Inox, regolabile, barra di supporto, fissaggio con tirante, avvitabile dal basso.

*Stainless Steel, adjustable, support bar, screw and bottom fixing.*

Imballo multiplo: 1 pz  
Multiple box: 1 pc

## Paracolpi per sedili wc in poliestere Sanilux Buffers for polyester toilet seats Sanilux

### RT10



**Cod. 1MIP01324**

RT10 h=10 mm  
Rettangolare  
*Rectangular*

### RT12



**Cod. 1MIP01693**

RT12 h=12 mm  
Rettangolare  
*Rectangular*

### TD7



**Cod. 1MIP01328**

TD7 h=7 mm  
Tondo  
*Round*

### TD10



**Cod. 1MIP01327**

TD10 h=10 mm  
Tondo  
*Round*

### SAGOMA A



**Cod. 1MIP01326**

Sagoma A  
*A shape*

### SAGOMA B



**Cod. 1MIP01325**

Sagoma B  
*B shape*

Imballo multiplo per tutti i ricambi cerniere e paracolpi in sacchetto: 6 pz  
Multiple box for all spare part hinges and buffers in polybag: 6 pcs

Paracolpi di ricambio per sedili wc in poliestere Sanilux  
*Buffers spare parts for polyester toilet seats Sanilux*



Set paracolpi per modelli wc/*Buffers set for wc models:*  
Universale, Aretusina, Ellisse, Piemonte/Piemontesina, Tesi

**Cod. 2FSE503702**

---



Set paracolpi per modelli wc/*Buffers set for wc models:*  
Clodia, Sintesi

**Cod. 2FSE503002**

---



Set paracolpi per modelli wc/*Buffers set for wc models:*  
Alpina, Quadrarco, Rio

**Cod. 2FSE503102**

---



Set paracolpi per modelli wc/*Buffers set for wc models:*  
Conca

**Cod. 2FSE503302**

Imballo multiplo per tutti i ricambi paracolpi in sacchetto: 12 pz  
*Multiple box for all spare part buffers in polybag: 12 pcs*

## Tabella colori per sedili wc in poliestere Sanilux Colours table for polyester toilet seats Sanilux

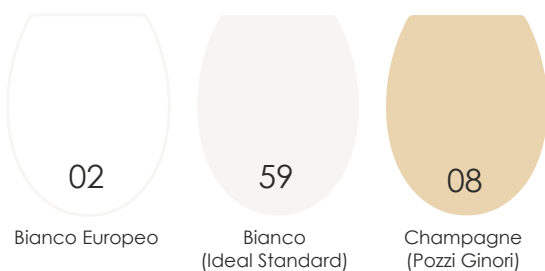

### NOTE

L'accettazione di un ordine per un sedile colorato è sottoposta ad approvazione Saniplast.

I sedili in MDF e Termoindurente sono disponibili solo nel colore bianco europeo o altrimenti specificato.

*The acceptance of an order for a colored seat is subject to Saniplast approval.*

*The seats in MDF and Durofort are available only in the european white color or in the mentioned colours.*

## Espositore ECO per sedili wc ECO display stand for toilets seats



Espositore in legno di Betulla  
con scorta per 15 scatole singole  
*Natural wood display stand  
with storage for 15 boxes*  
Dim.: 51x44x145 (h) cm

**Cod. 2FSE548802**





## Principali adattabilità per forma Main adaptability by shape

Le adattabilità sono puramente indicative e vanno controllate con le dimensioni dei sedili  
The adaptability is purely indicative and must be checked with the size of the seats

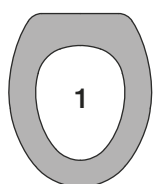

Forma = CW 01  
CW 06  
CW 09  
CW 203

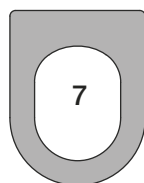

Forma = CW 10 CW 223  
CW 11 CW 253  
CW 12 CW 254  
CW 16 CW 283  
CW 17  
CW 21  
CW 43

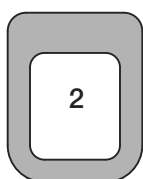

Forma = CW 02  
CW 84

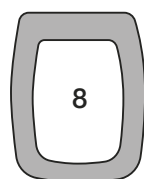

Forma = CW 15  
CW 216  
CW 262

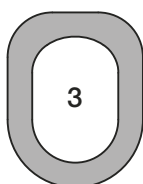

Forma = CW 03  
CW 13  
CW 17  
CW 32  
CW 60  
CW 283

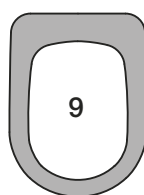

Forma = CW 13  
CW 14  
CW 17  
CW 26  
CW 575

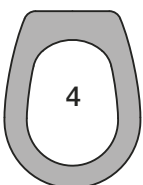

Forma = CW 04

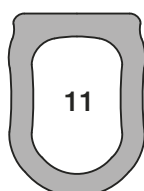

Forma = CW 206  
CW 232



Forma = CW 05  
CW 216  
CW 262

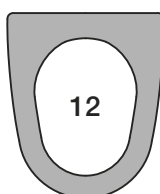

Forma = CW 264

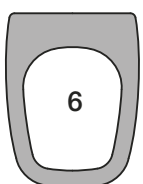

Forma = CW 07

# Aiutaci a individuare il tuo sedile wc - Help us to find your toilet seat

Inviare il modulo compilato tramite e-mail all'indirizzo: [iltuosedile@saniplast.it](mailto:iltuosedile@saniplast.it)

Send the completed form by e-mail to the address: [iltuosedile@saniplast.it](mailto:iltuosedile@saniplast.it)

Individua il tuo sedile wc allegando una o più **fotografie** della ceramica o del sedile.  
Find your toilet seat by attaching one or more **pictures** of the ceramic or the seat.

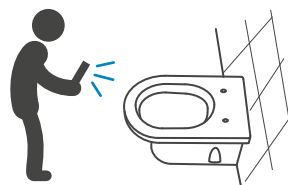

Indica la forma , la **marca** e il colore del tuo vaso ceramica.  
Indicate the shape , **brand** and color of your ceramic bowl.

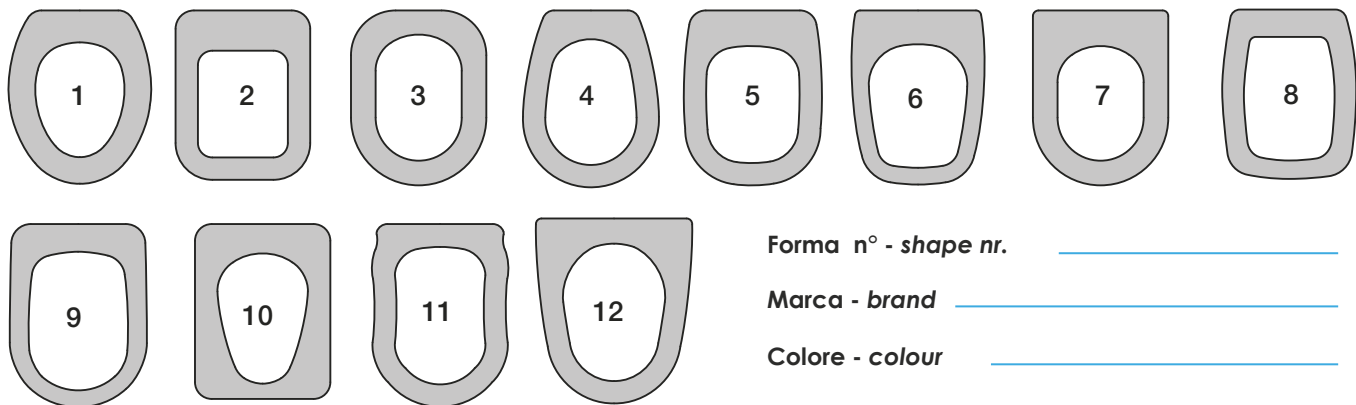

Forma n° - shape nr. \_\_\_\_\_

Marca - brand \_\_\_\_\_

Colore - colour \_\_\_\_\_

Indica il tipo di **fori** del tuo vaso ceramica.  
Indicate the type of **holes** in your ceramic bowl.

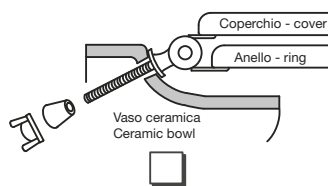

Cerniere per vaso con **fori obliqui**  
Hinges for vase with oblique holes

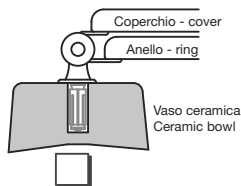

Cerniere per vaso con **fori ciechi**  
Hinges for pots with blind holes

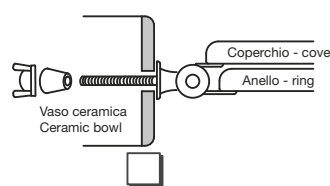

Cerniere per vaso con **fori orizzontali**  
Hinges for vase with horizontal holes

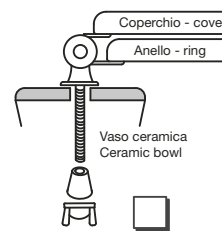

Cerniere per vaso con **fori passanti**  
Hinges for toilet with through holes

Indica il **paraurti** adatto all'anello del tuo sedile wc.  
Indicate the **buffer** suitable for the ring of your toilet seat.

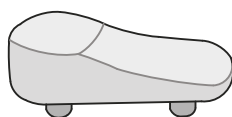

Paraurti **autocentrante** sagoma "B"  
Self-centering bumper shape "B"

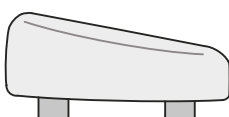

Paraurti **conico** sagoma "A"  
Conical bumper shape "A"



Paraurti **piano** "RT"  
"RT" flat bumper

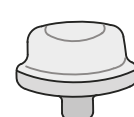

Paraurti **tondo** "TD"  
Round bumper "TD"

Fai una semplice **misurazione** del tuo vaso ceramica.  
Take a simple **measurement** of your ceramic bowl.

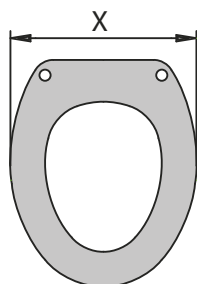

Larghezza cm \_\_\_\_\_  
Width

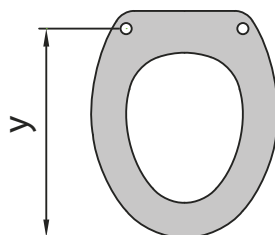

Dai fori alla punta cm \_\_\_\_\_  
From the holes to the tip

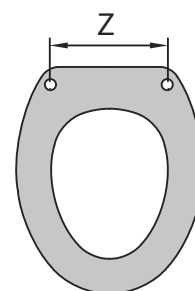

Interasse fori cm \_\_\_\_\_  
Distance between holes

Indirizzo o timbro del richiedente - Applicant's address or stamp



Via G. Falcone, 10 - 25035 Ospitaletto (BS) Italia  
tel. +39 030 6577241 - fax +39 030 657405





# CONDIZIONI GENERALI DI VENDITA

## ACCETTAZIONE ORDINI ED AVADIBILITÀ

Gli ordini con valore merce inferiore a € 150,00 verranno evasi unicamente con pagamento anticipato e spese amministrative di € 30,00.

## MODALITÀ DI RESA

Ordini d'importo netto < € 650,00 Porto Franco con addebito costo trasporto  
Ordini d'importo netto > € 650,00 Porto Franco

## PREZZI

I prezzi si intendono per merce resa franco stabilimento di Ospitaletto (BS) IVA esclusa, imballo standard compreso nel prezzo. Qualora nell'ordine non vengano rispettati i multipli di imballo standard, i prezzi verranno maggiorati di un extra 6%. Possono essere variati senza preavviso e si intendono validi solo quelli in vigore all'atto della consegna del materiale. L'accettazione degli ordini è soggetta alla approvazione della Casa Fornitrice.

## CONSEGNA

La merce è venduta franco stabilimento e viaggia sempre a rischio e pericolo del Committente. La Casa Fornitrice si riserva la facoltà di evadere un ordine con più consegne, se non espressamente richiesto dalla Committente.

La consegna, salvo richiesta di trasporto assegnato, sarà effettuata con Corriere di fiducia della Casa Fornitrice.

## TRASPORTO

Ogni spedizione eseguita dalla Casa Fornitrice, che si riserva la scelta del vettore di fiducia, avviene per incarico e conto del Committente, pertanto la stessa non sarà responsabile di eventuali ritardi, disguidi, rotture, furti, ammacchi e conseguentemente non sostituirà né accrediterà la merce manomessa, danneggiata o perduta nel corso del trasporto.

Al Committente spetta quindi di fare reclamo al vettore, all'atto della ricezione della merce, per ogni eventuale danno o disguido verificatosi.

## IMBALLI

Le caratteristiche dell'imballo saranno ad esclusiva decisione della Casa Fornitrice, salvo precedenti soluzioni accettate.

## TERMINI DI CONSEGNA

Il termine di consegna o di spedizione ha valore semplicemente informativo e non impegnativo, resta quindi esclusa ogni responsabilità della Casa Fornitrice per ritardi o per mancata consegna a qualsiasi causa imputati.

## PAGAMENTI

I termini di pagamento specificati in fattura si intendono tassativi. Non si accettano condizioni difformi se non preventivamente ed espressamente pattuite. Gli assegni rilasciati in pagamento dovranno essere sempre e comunque intestati alla Saniplast Industry S.r.l. La Casa Fornitrice si riserva il diritto di sospendere o annullare forniture in corso di spedizione ed ogni altro eventuale ordine già accettato, qualora i pagamenti non siano effettuati nei termini stabiliti. Eventuali contestazioni di qualsiasi natura non conferiscono al Committente la facoltà di sospendere i pagamenti in corso.

## INTERESSI DI MORA

L'inosservanza dei termini di pagamento pattuiti determinerà l'addebito, da parte della Casa Fornitrice, degli interessi al primerate bancario aumentato di 4 punti.

## RESPONSABILITÀ

La Casa Fornitrice, previa autorizzazione, accetterà in restituzione unicamente i prodotti riconosciuti difettosi per vizi di fabbricazione ed accrediterà l'importo della merce resa al prezzo di acquisto. Nessun articolo può essere reso senza esplicito benestare della Casa Fornitrice, i resi autorizzati dovranno pervenire alla fabbrica o alle filiali, a seconda delle decisioni della Fornitrice, in porto franco e saranno gravati delle eventuali spese, che fosse necessario sostenere, dovute all'incuria del cliente. La Fornitrice, inoltre, si riserva di visionare e, se del caso, distruggere in loco materiale riconosciuti difettosi, per i quali accrediterà il valore di acquisto. E' fatto assoluto divieto agli acquirenti, di effettuare qualsiasi lavorazione ulteriore, comprese decorazioni o simili, sui prodotti della Casa Fornitrice. E' fatto assoluto obbligo al cliente di citare la fattura di acquisto corrispondente.

## CARATTERISTICHE TECNICHE

La Saniplast Industry S.r.l. si riserva di apportare eventuali modifiche tecniche ed estetiche a tutti i prodotti della propria produzione, in qualsiasi momento.

I modelli possono essere modificati o soppressi senza preavviso.

## RECLAMI

Ogni fornitura s'intende accettata trascorsi 7 giorni dal ricevimento della merce senza reclami.

Per essere presi in considerazione, i reclami dovranno essere fatti a mezzo lettera raccomandata o via fax e/o Email.

## DATI IDENTIFICATIVI DEL COMMITTENTE

Il Committente è responsabile di tutti i dati di identificazione forniti alla Saniplast Industry S.r.l. quali: Denominazione o Ragione Sociale, Residenza o Domicilio, Sede, Codice Fiscale e quant'altro richiesto dalla legislazione vigente.

## DOMICILIO LEGALE

Per qualsiasi controversia tra la Fornitrice ed il Committente, sarà sempre e solo competente il Foro di Brescia.

**LE PRESENTI CONDIZIONI DI VENDITA SI INTENDONO ACCETTATE CON L'ORDINE.**

# GENERAL SALES CONDITIONS

## ORDER ACCEPTANCE

Orders with lower value than € 150,00 will be processed only with advance payment and administration costs of € 30,00. Transportation costs are to be paid by customer.

## DELIVERY TERMS

Delivery terms will be regulated for each single country of destination.

## PRICES

Prices are ex-works and goods travel at customer's risk.

In case the order does not respect the packaging minimum quantity, the price will be increased with an extra 6%. Prices may change without any notice and are valid those in effect at the time of delivery. Acceptance of orders is subjected to approval by the Head Quarter.

## TRANSPORT

Transport is paid by the customer. All shipments from the supplier are commissioned by and on behalf of the client. The supplier reserves the right to choose the courier. The supplier will not be liable for any delay, error, breakage or theft, therefore it will not replace or credit the goods damaged or lost during transportation.

The customer is entitled to complain to the courier upon receipt of the goods, for any occurred damage or inconvenience.

## DELIVERY

The delivery time is merely informative and not binding, therefore the supplier does not accept liability for delay or failure to deliver due to any cause.

## PACKAGING

The characteristics of the package will be exclusively chosen by the supplier.

## PAYMENT

The payment terms in the invoice specified are mandatory. Any other condition is not accepted unless previously and expressly agreed. The issued cheques must always be payable to Saniplast Industry S.r.l. The supplier reserves the right to suspend or cancel deliveries and any other order already accepted, if payments are not made within the deadline. Any kind of dispute does not give the purchaser the right to suspend payments in course. The delivery of the first order to a new customer will be made only with cash payment against delivery or with prepayment.

## INTEREST ON ARREARS

In case of failure to comply with the agreed payment terms, the supplier will have the right to determine the charge of the interest according to the bank prime rate increased by 4 points.

## RESPONSIBILITY

Upon authorization, the supplier may accept in return only those products which show production defects and will credit the amount of delivered goods at the purchase price. No product can be returned without the express approval of the supplier. The authorized returns must be sent to the supplier on free delivery base. The supplier may charge to the customer any cost about the return of the goods in case of customer's negligence. The supplier also reserves the right to inspect and, whenever necessary, to destroy on-site defective material, for which it will credit the purchase value. It is absolutely forbidden to the buyer to perform any further process, including decorations or similar, on supplier's products. The customers are required to quote the relevant invoice.

## TECHNICAL SPECIFICATIONS

The supplier reserves the right to make technical and aesthetic changes to the products of its production at any time. Models can be modified or canceled without any notice.

## COMPLAINTS

Each delivery will be considered as accepted after 7 days of receipt of goods without complaints. In case of complaint, this must be communicated to the supplier by registered mail or by fax.

## CUSTOMER'S IDENTIFICATION

The buyer is responsible for all identification data provided to the supplier such as: name or company name, residence or domicile, tax code and any other data required by current law.

## LEGAL DOMICILE

Any dispute between the supplier and the customer will be handled only by the Court in Brescia.

**THESE SALES CONDITIONS ARE ACCEPTED TOGETHER WITH THE ORDER.**



Saniplast Industry S.r.l. - Via G. Falcone, 10 - 25035 OSPITALETTO (BS)  
C.F. e P. IVA: IT 04118780982  
Tel. +39 030 65 77 241 - Fax +39 030 65 74 05  
[info@saniplast.it](mailto:info@saniplast.it)





Azienda di produzione italiana  
*Italian manufacture company*

[www.saniplast.it](http://www.saniplast.it)